

50 ANOS

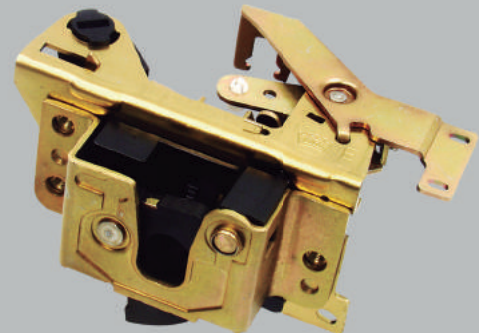

Zinni & Güell Ltda

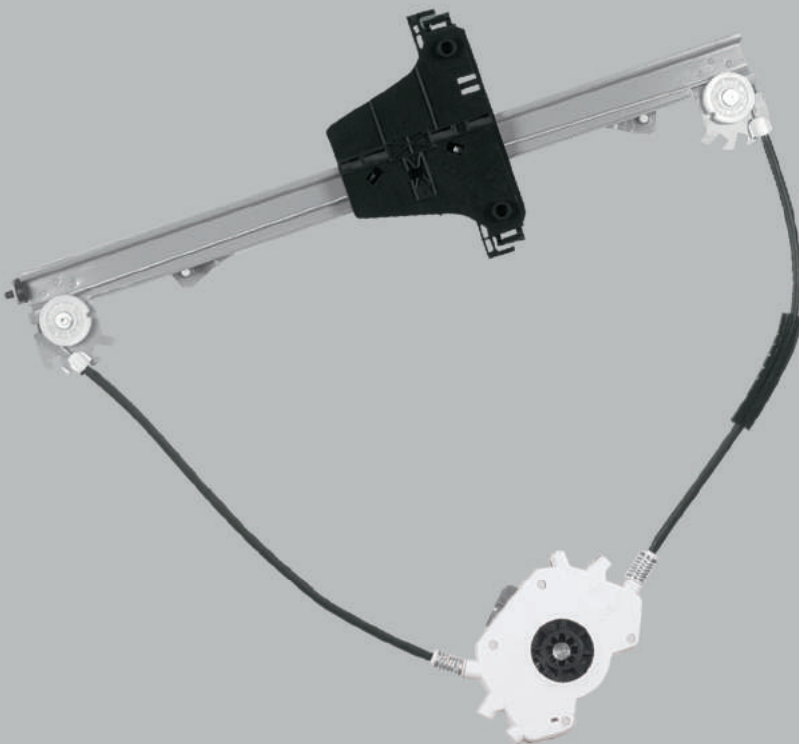

EDIÇÃO ABRIL 2015

ÍNDICE

LINHA MECÂNICA

Linha Fiat	04
Linha Mercedes-Benz	06
Linha Scania.....	08
Linha Volvo.....	09
Linha Toyota.....	10
Linha General Motors.....	11
Linha Volkswagen.....	14
Linha Ford.....	22
Linha Renault	24
Linha Kia	24
Linha Produtos Especiais.....	25

LINHA ELÉTRICA

Linha Fiat	27
Linha Mercedes-Benz.....	30
Linha Scania.....	31
Linha Volvo.....	31
Linha General Motors.....	32
Linha Volkswagen	37
Linha Ford	42
Linha Mitsubishi	45
Linha Renault.....	46
Linha Peugeot.....	48
Linha Nissan.....	48
Linha Toyota	49
Linha Hyundai.....	50
Linha Motores.....	51



Zinni & Güell Ltda

LINHA
MECÂNICA

A **Zinni & Güell Ltda**, completa 50 anos de fabricação de levantadores de vidro manuais e elétricos, fechaduras e fechos de capô para vários tipos de veículos.

Possui um parque Industrial de 20.000 m², com 7.000 m² de área construída, com setor fabril de Fundição de Zamak e Alumínio, Estamparia, Usinagem, Galvanoplastia e Ferramentaria com equipamentos automatizados de última geração e rigoroso acompanhamento nas fases do processo produtivo, que permitem uma produção com qualidade garantida.



*Fechaduras
Cerraduras de La Puerta
Door Locks

*Máquinas Reguladoras do Vidro Mecânicas
Levanta Cristales Mecânicas
Window Lifter Mechanism

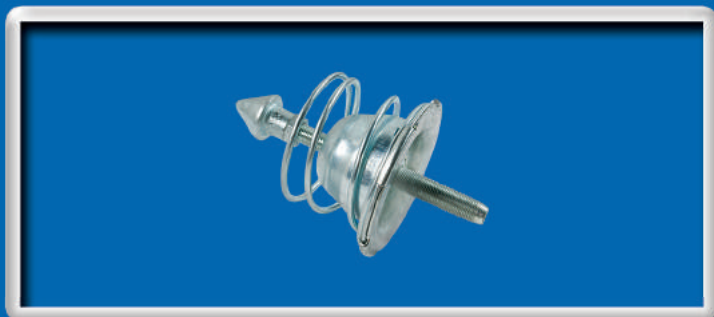
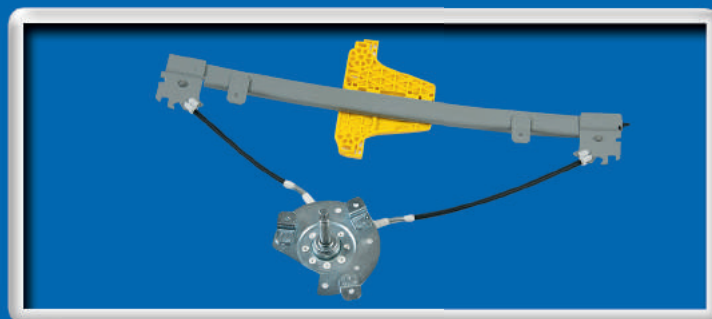

*Fecho do Capô
Cierre Del Capot
Hood Latches

www.zinnieguell.com.br



147

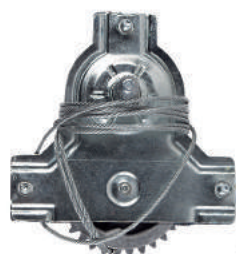

R-1111
Máquina Reguladora
Fiat 147 - Modelo Único
Nº Orig. 426.67.91

147



F-1209
Fechadura porta malas
c/ chave
Fiat 147
Nº Orig. 433.61.74

UNO



R-1416 E/D
Máquina Reguladora
Uno 2P 2011... / Fiorino 2014...
Nº Orig. 51.835.882 (LE) / 51.835.881 (LD)

UNO



R-1417 E/D
Máquina Reguladora
Uno 4P DNT. 2010...
Nº Orig. 51.835.878 (LE) / 51.835.597 (LD)

UNO

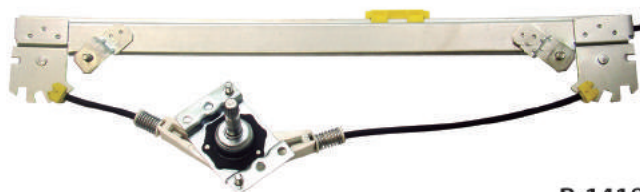

R-1418 E/D
Máquina Reguladora
Uno 4P TRS. 2010...
Nº Orig. 51.835.880 (LE) / 51.835.879 (LD)

IVECO DAILY



R-1419 E/D
Máquina Reguladora
Iveco Daily 35S14/ 40S16/
55S14 2008... / Master 2008...2013
Nº Orig. 504.205.271 (LE) / 504.205.269 (LD)

UNO

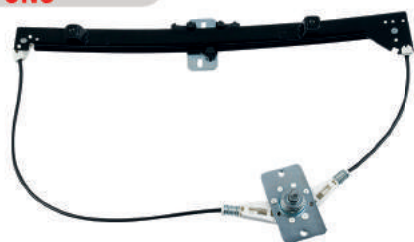

R-1420 E/D
Máquina Reguladora
Uno / Prêmio / Elba 2P
Nº Orig. 50.006.099 (LE) / 50.006.098 (LD)

UNO

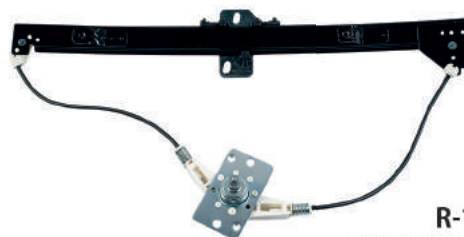

R-1421 E/D 4D
Máquina Reguladora
Fiat Uno 4P DNT. / Prêmio / Elba / Fiorino
Nº Orig. 50.003.667 (LE) / 50.003.666 (LD)

UNO

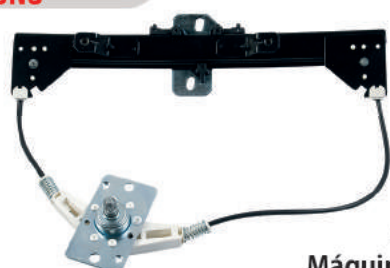

R-1421 E/D 4T
Máquina Reguladora
Fiat Uno / Prêmio / Elba 4P TRS.
Nº Orig. 50.003.669 (LE) / 50.003.668 (LD)

IVECO DAILY



R-1422 E/D
Máquina Reguladora
Fiat Iveco Daily ...2007
Nº Orig. 93.941.271 (LE) / 93.941.270 (LD)

DUCATO



R-1423 E/D
Máquina Reguladora
 Ducato 99... / Boxer 2000... / Jumper 2007...
Nº Orig. 1.320.338.080 (LE) / 1.320.337.080 (LD)

IVECO STRALIS



R-1424 E/D
Máquina Reguladora
 Iveco Stralis / Eurocargo / Tector / Cavallino 320 Todos 98...
Nº Orig. 2.997.186 (LE) / 2.997.185 (LD)

PALIO

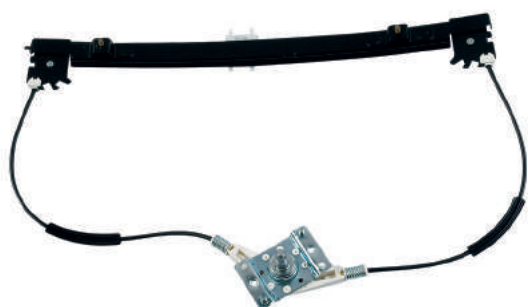

R-1437 E/D
Máquina Reguladora
 Palio 2P / Pick-up Strada 96...
Nº Orig. 46.446.909 (LE) / 46.446.908 (LD)

PALIO

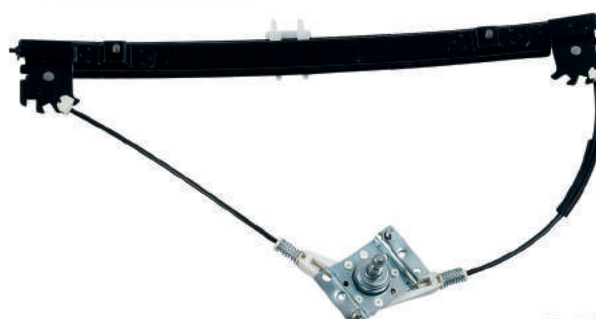

R-1438 E/D
Máquina Reguladora
 Palio / Siena / Weekend 4P DNT. 96... 2012
Nº Orig. 46.446.913 (LE) / 46.446.912 (LD)

PALIO

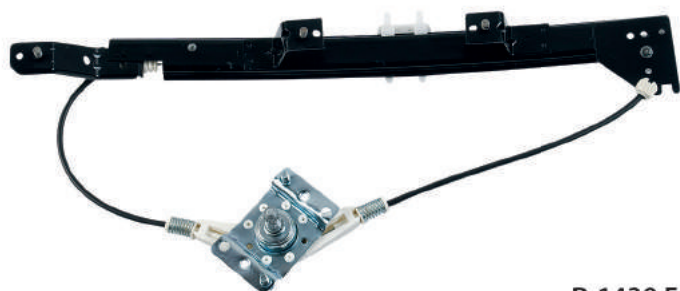

R-1439 E/D
Máquina Reguladora
 Palio / Siena / Weekend 4P TRS. 96... 2012
Nº Orig. 46.446.911 (LE) / 46.446.910 (LD)

UNO

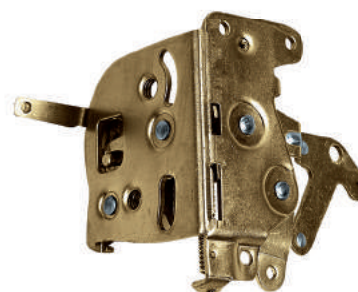

F-1440 E/D
Fechadura Interna
 Uno / Prêmio / Elba 2P - Todos
Nº Orig. 7.515.950 (LE) / 7.516.181 (LD)

UNO



F-1441 E/D
Fechadura Interna
 Uno / Prêmio / Elba 4P DNT. / Fiorino - Todos
Nº Orig. 5.941.514 (LE) / 5.941.513 (LD)

DOBLÔ



R-1442 E/D
Máquina Reguladora
 Doblô 2002...
Nº Orig. 51.720.129 (LE) / 51.720.130 (LD)

HPN



R-2120 E/D
Máquina Reguladora
 Caminhão Mercedes Benz
 709 / 1935 / LS 1938 / L1218 / L 1418 2001...
Nº Orig. 688.720.76.46 (LE) / 688.720.75.46 (LD)

1111/1113



R-2121 E/D
Máquina Reguladora
 Caminhão Mercedes Benz
 1111-1113-1313-1513-2013 / 2213 73... 82 Pino Curto
Nº Orig. 344.768.00.01 (LE) / 344.768.01.01 (LD)

1111/1113



R-2122 E/D
Máquina Reguladora
 Caminhão Mercedes Benz
 1111-1113-1313-1513-2013 / 2213 83... 90 Pino Longo
Nº Orig. 331.725.70.02 (LE) / 331.725.71.02 (LD)

HPN



R-2123 E/D
Máquina Reguladora
 Caminhão Mercedes Benz
 507 / 709 / 809 / 811 / 909 / 1938 91... 2000 Pino Longo
Nº Orig. 688.720.70.46 (LE) / 688.720.71.46 (LD)

EXPORTAÇÃO



R-2124 E/D
Máquina Reguladora
 Caminhão Mercedes Benz 91... Pino Longo - Exportação
Nº Orig. 381.725.00.02 (LE) / 381.725.01.02 (LD)

608



R-2125 E/D
Máquina Reguladora
 Caminhão Mercedes Benz 608 83...
Nº Orig. A308.670.7203 (LE) / A308.670.7303 (LD)

608



F-2300 E/D
Fechadura
 Caminhão Mercedes Benz 608 83...
Nº Orig. A308.720.7035 (LE) / A308.720.7135 (LD)

1113

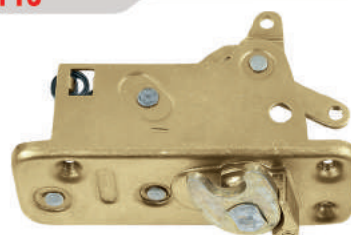

F-2301 E/D
Fechadura
 Caminhão Mercedes Benz
 1111-1113-1313-1513-2013-2213 ...90
Nº Orig. A344.720.7035 (LE) / A344.720.7135 (LD)

1113... 2213

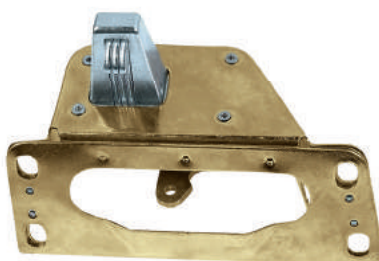

F-2302-I
Fecho do Capô Inferior
 1111-1113-1313-1513-2013-2213 ...90
Nº Orig. 332.880.00.60 (Inf.)

1111... 2213

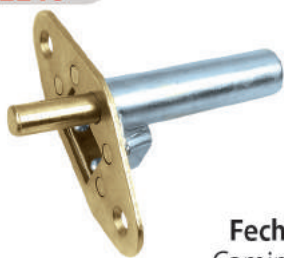

F-2302-S
Fecho do Capô Superior
 Caminhão Mercedes Benz
 1111-1113-1313-1513-2013-2213 ...90
Nº Orig. 332.880.01.60 (Sup.)

709/909



F-2303 E/D
Fechadura Interna
 Caminhão Mercedes Benz 709 / 909 ...96
Nº Orig. 688.720.7035 (LE) / 688.720.7135 (LD)

SPRINTER



R-2304 E/D
Máquina Reguladora
 Sprinter 97...
Nº Orig. 901.720.14.46 (LE) / 901.720.15.46 (LD)

EXPORTAÇÃO

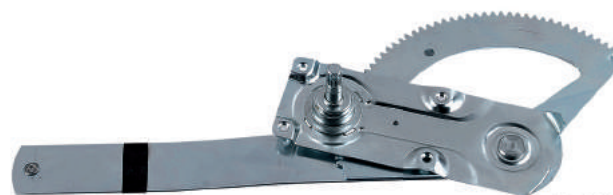

R-2305 E/D
Máquina Reguladora
 Caminhão Mercedes Benz Alemão - Exportação
Nº Orig. E-00000/D-00000

1418... 1620

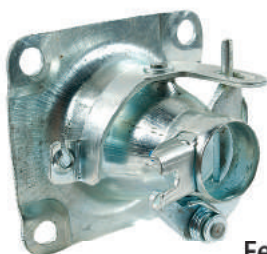

F-2306I
Fecho do Capô Inferior
 Caminhão Mercedes Benz 2001...
Nº Orig. I- A 694.880.02.60 (Inf.)

1418... 1620



F-2306S
Fecho do Capô Superior
 Caminhão Mercedes Benz 2001...
Nº Orig. S- A 694.880.00.60 (Sup.)

ATEGO

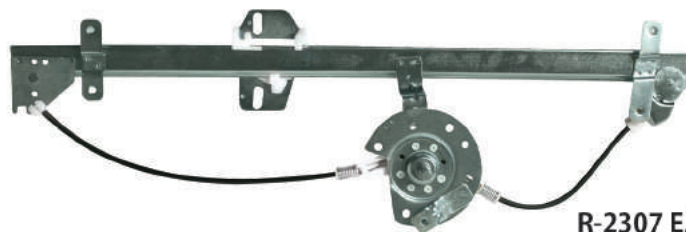

R-2307 E/D
Máquina Reguladora
 Caminhão Mercedes Benz 1938 S / Atego / Axor / Actros 2006...
Nº Orig. 973.720.01.46 (LE) / 973.720.02.46 (LD)

ACCELO

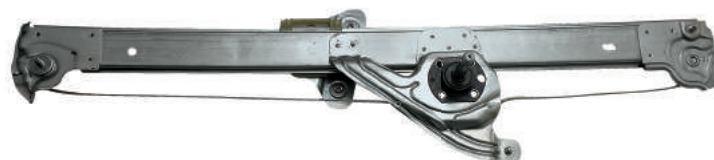

R-2308 E/D
Máquina Reguladora
 Caminhão Mercedes Benz Accelo 815 / 1016 2012...
Nº Orig. 979.720.11.46 (LE) / 979.720.12.46 (LD)

1214... 1618



F-2309I
Fecho do Capô Inferior
 Caminhão Mercedes Benz ...2000
Nº Orig. A-384.880.76.60 (Inf.)

1214... 1618



F-2309S
Fecho do Capô Superior
 Caminhão Mercedes Benz ...2000
Nº Orig. A-384.880.76.60 (Sup.)

L75



R-2601 E/D
Máquina Reguladora
Caminhão Scania L75 / L76 70... 74
Nº Orig. 66.735 (LE) / 66.736 (LD)

L110

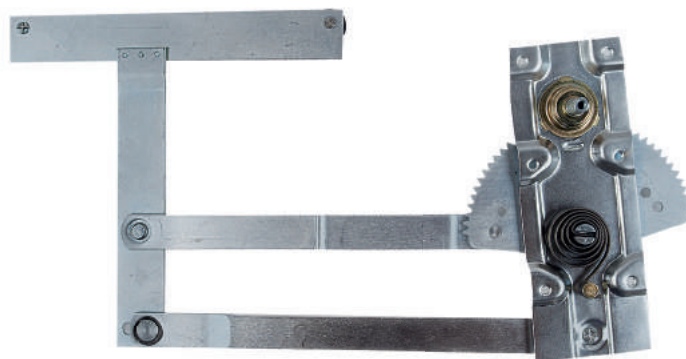

R-2602 E/D
Máquina Reguladora
Caminhão Scania L110 / 111 75...80
Nº Orig. 236.255 (LE) / 236.256 (LD)

T/R



R-2603 E/D
Máquina Reguladora
Caminhão Scania T/R 81...87
Nº Orig. 296.429 (LE) / 296.430 (LD)

T/R



R-2604 E/D
Máquina Reguladora
Caminhão Scania T/R 88...97
Nº Orig. 524.783 (LE) / 524.784 (LD)

LK140

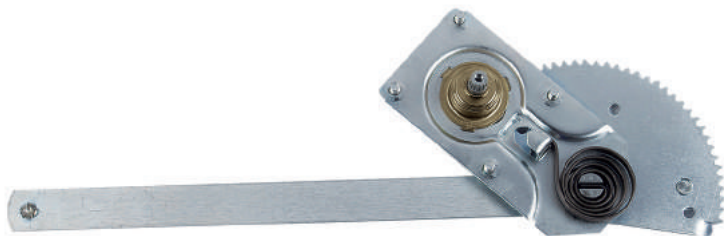

R-2605 E/D
Máquina Reguladora
Caminhão Scania LK 140/141 88...
Nº Orig. 187.719 (LE) / 187.720 (LD)

SÉRIE 4

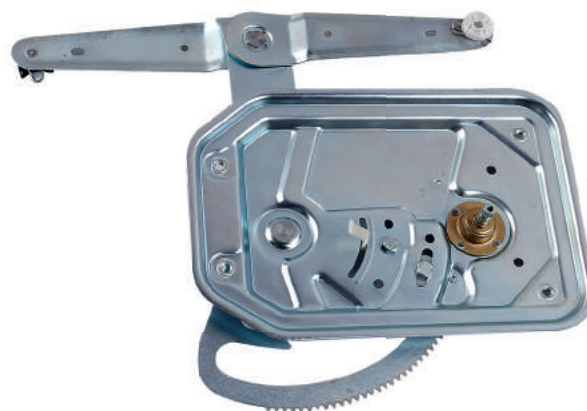

R-2606 E/D
Máquina Reguladora
Caminhão Scania Série 4 98...
Nº Orig. 1.366.847 (LE) / 1.366.848 (LD)

VOLVO ...89



R-2610 E/D
Máquina Reguladora
Caminhão Volvo ...89 Cabine Curta
Nº Orig. 6.889.223 (LE) / 6.889.224 (LD)

NL 10

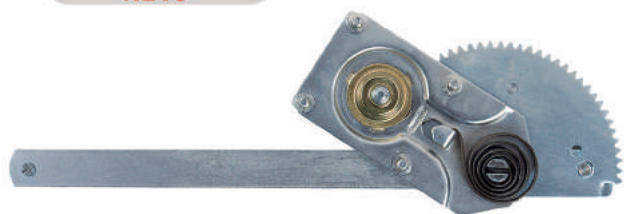

R-2612 E/D
Máquina Reguladora
Caminhão Volvo NL10/NL12 90... 94 Braço - Cabine Normal
Nº Orig. 8.123.247 (LE) / 8.123.248 (LD)

FH FM

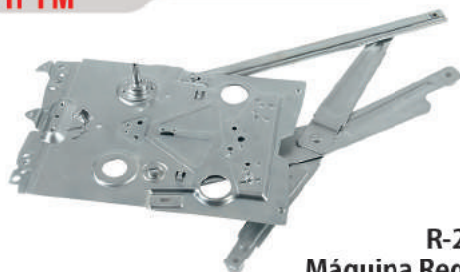

R-2617 E/D
Máquina Reguladora
Caminhão Volvo FH12 / FH13 / FM 94...
Nº Orig. 31.76.541 (LE) / 31.76.542 (LD)

NH

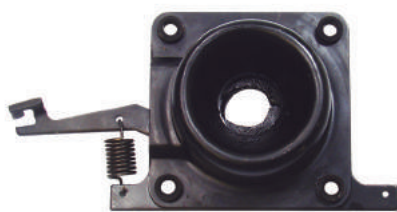

F-2917 E/D
Fecho do Capô Inferior
Caminhão Volvo NH 99...2006
Nº Orig. 20.565.618 (LE) / 20.565.619 (LD)

NL 10/12

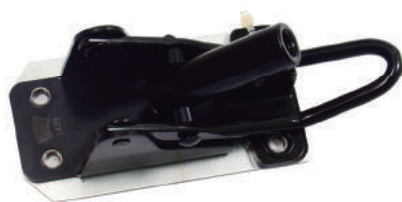

F-2919
Gancho Externo da Trava do Capô
Caminhão Volvo NL 10/12 ...99
Nº Orig. 1.606.661

NL 10

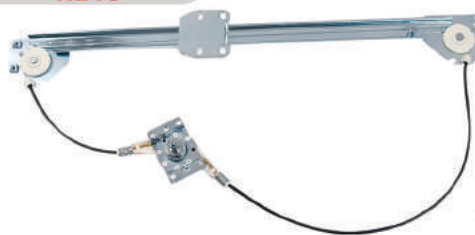

R-2611 E/D
Máquina Reguladora
Caminhão Volvo NL10/NL12 90... 94 Cabine Longa
Nº Orig. 8.123.657 (LE) / 8.123.658 (LD)

VM



R-2616 E/D
Máquina Reguladora
Caminhão Volvo VM 2004... Todos
Nº Orig. 20.557.548 (LE) / 20.557.550 (LD)

VOLVO 92...

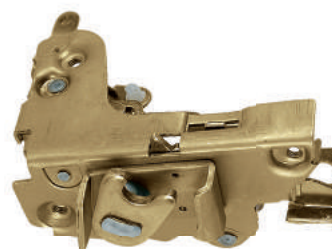

F-2915 E/D
Fechadura
Caminhão Volvo 92...
Nº Orig. 8.123.611 (LE) / 8.123.612 (LD)

NH



F-2918
Fecho do Capô Superior Pino
Caminhão Volvo NH 99...2006
Nº Orig. 8.081.394

NL 10/12



F-2920
Trava (Tubo) do Capô
Caminhão Volvo NL 10/12 ...99
Nº Orig. 1.612.396

BANDEIRANTE

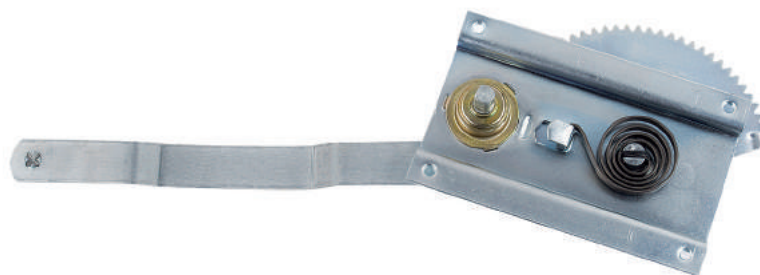

R-2620 E/D
Máquina Reguladora
Toyota ...81 - Pino Quadrado
Nº Orig. 6980.298.001B (LE) / 6980.198.001B (LD)

BANDEIRANTE

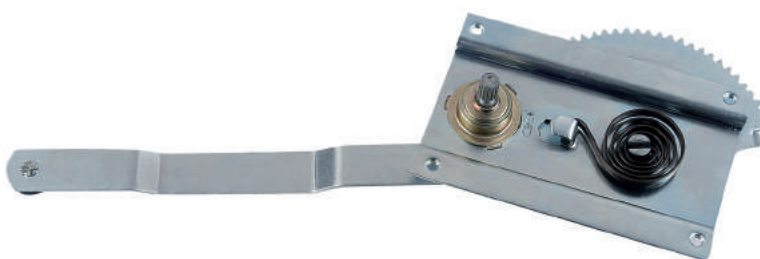

R-2621 E/D
Máquina Reguladora
Toyota 82...83 - Pino Estriado
Nº Orig. 6980.298.002A (LE) / 6980.198.002A (LD)

BANDEIRANTE



R-2622 E/D
Máquina Reguladora
Toyota 84... - Pino Estriado
Nº Orig. 6.980.298.003 (LE) / 6.980.198.003 (LD)



CHEVETTE

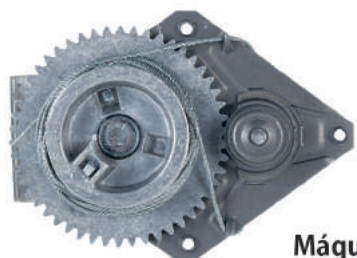

R-3112 E/D
Máquina Reguladora
Chevette / Marajó ...82 Todos
Nº Orig. 92.995.81 (LE) / 92.995.82 (LD)

CHEVETTE



R-3112 E/D 83
Máquina Reguladora
Chevette 83...84
Nº Orig. 94.626.685 (LE) / 94.626.686 (LD)

CHEVETTE



R-3112 E/D 4D
Máquina Reguladora
Chevette / Marajó 4P DNT. 83...
Nº Orig. 94.633.631 (LE) / 94.633.632 (LD)

CHEVETTE



R-3112 E/D 4T
Máquina Reguladora
Chevette 4P TRS. 83...
Nº Orig. 94.633.653 (LE) / 94.633.654 (LD)

OPALA



R-3113 E/D
Máquina Reguladora
Opala / Caravan 2P
Nº Orig. 73.310.79 (LE) / 73.310.80 (LD)

OPALA



R-3113 E/D 4D
Máquina Reguladora
Opala / Caravan 4P DNT.
Nº Orig. 73.238.84 (LE) / 73.238.85 (LD)

OPALA



R-3113 E/D 4T
Máquina Reguladora
Opala / Caravan 4P TRS.
Nº Orig. 73.239.07 (LE) / 73.239.08 (LD)

PICK-UP C10



R-3114 E/D
Máquina Reguladora
Caminhão / Pick-up C10 / D10 / Pick-up ...85
Nº Orig. 73.200.91 (LE) / 73.200.92 (LD)

MONZA



R-3115 E/D
Máquina Reguladora
Monza SLE 4P DNT. 83...96 Todos
Nº Orig. 90.035.195 (LE) / 90.035.196 (LD)

D20



R-3116 E/D
Máquina Reguladora
Caminhão / Pick-up D20 85...90
Nº Orig. 94.637.551 (LE) / 94.637.552 (LD)

MONZA



R-3320 E/D
Máquina Reguladora
 Monza 2 Portas 83...96 - Todos
 Nº Orig. 94.649.469 (LE) / 94.649.470 (LD)

MONZA

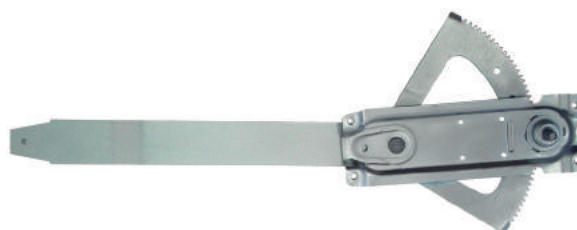

R-3322 E/D
Máquina Reguladora
 Monza 2P - Cremalheira ...83
 Nº Orig. 90.035.485 (LE) / 90.035.486 (LD)

KADETT

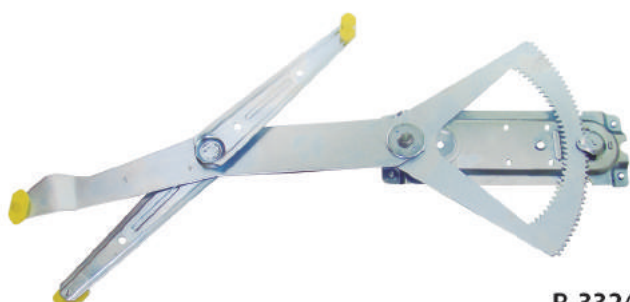

R-3324 E/D
Máquina Reguladora
 Kadett Todos / Ipanema 2P 89...98
 Nº Orig. 52.280.827 (LE) / 52.280.828 (LD)

CELTA



R-3336 E/D
Máquina Reguladora
 Celta 2P ...2006 Pino Curto
 Nº Orig. 93.260.865 (LE) / 93.260.866 (LD)

CORSA



R-3337 E/D
Máquina Reguladora
 Corsa 4P DNT. / Montana 2002...2010
 Nº Orig. 93.382.279 (LE) / 93.382.280 (LD)

CELTA

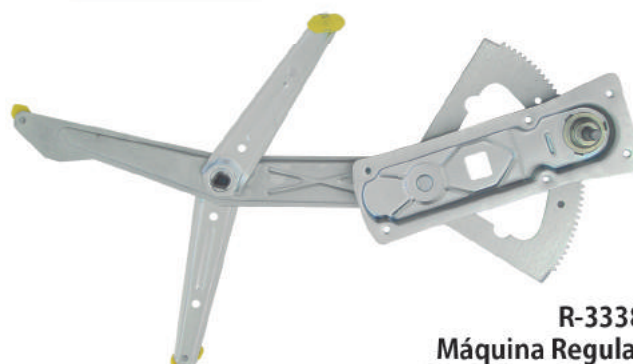

R-3338 E/D
Máquina Reguladora
 Celta 2P - 2007... Pino Longo
 Nº Orig. 93.373.221 (LE) / 93.373.222 (LD)

PRISMA



R-3339 E/D
Máquina Reguladora
 Celta 4P 2000...2006 Prisma 4P 2006... DNT. Pino curto
 Nº Orig. 93.363.825 (LE) / 93.363.824 (LD)

CORSA

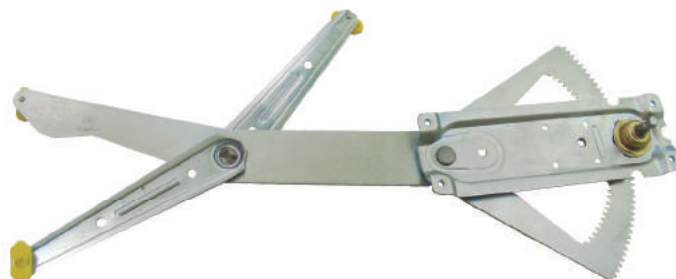

R-3342 E/D
Máquina Reguladora
 Corsa 2P/ Pick-up Corsa ...2001
 Nº Orig. 90.388.865 (LE) / 90.388.866 (LD)



CORSA



R-3343 E/D
Máquina Reguladora
 Corsa 4P 96...2001 / Classic 4P DNT. 96...
Nº Orig. 90.388.861 (LE) / 90.388.862 (LD)

S 10



R-3345 E/D
Máquina Reguladora
 S10 Todas / Blazer DNT. 95...2011
Nº Orig. 15.705.141 (LE) / 15.705.142 (LD)

BONANZA

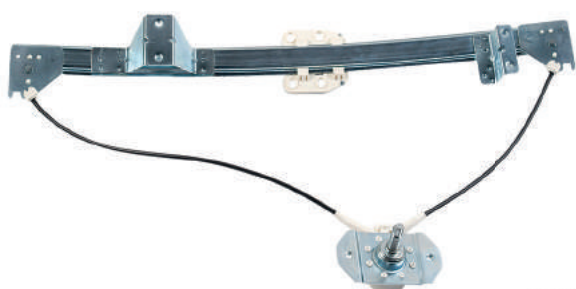

R-3346 E/D
Máquina Reguladora
 Bonanza / Veraneio / A/C / D20A / D40 D12000 DNT. 91...
Nº Orig. 52.255.121 (LE) / 52.255.122 (LD)

BONANZA



R-3347 E/D
Máquina Reguladora
 Bonanza / Veraneio / A/C / D20 A/ D40 D12000 TRS. 91...
Nº Orig. 52.255.125 (LE) / 52.255.126 (LD)

CORSA



R-3348 E/D
Máquina Reguladora
 Corsa 4P TRS. 96...2001 / Classic 96... TRS.
Nº Orig. 90.389.535 (LE) / 90.389.536 (LD)

CELTA



R-3350 E/D
Máquina Reguladora
 Celta 4P / Prisma 4P DNT. 2007... Pino Longo
Nº Orig. 93.372.629 (LE) / 93.372.630 (LD)

CORSA

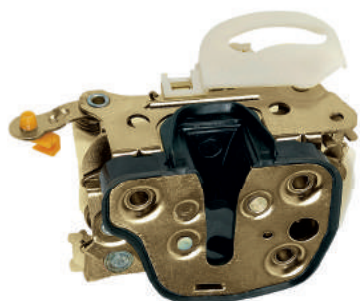

F-3355 E/D
Fechadura
 Corsa 2/4P DNT ...2001 Classic 96...
Nº Orig. 90.452.381 (LE) / 90.452.382 (LD)

CORSA



F-3356 E/D
Fechadura
 Corsa 4P TRS ...2001 Classic 96...
Nº Orig. 90.482.461 (LE) / 90.482.462 (LD)

KOMBI



R-4099 E/D
Máquina Reguladora

Kombi 2008...

Nº Orig. 7X0.837.501 (LE) / 7X0.837.502 (LD)

GOL



R-4100 E/D
Máquina Reguladora

Gol Special 2P GIII / GIV 2001...2011

Nº Orig. 5X0.837.501 (LE) / 5X0.837.502 (LD)

VOYAGE



R-4101 E/D
Máquina Reguladora

Voyage 4P - Argentino Pino Curto ...87

Nº Orig. 302.837.501-2 (LE) / 302.837.502-2 (LD)

VOYAGE



R-4103 E/D
Máquina Reguladora

Voyage 4P - Argentino Pino Longo 88...95

Nº Orig. 302.837.501-7 (LE) / 302.837.502-7 (LD)

GOL

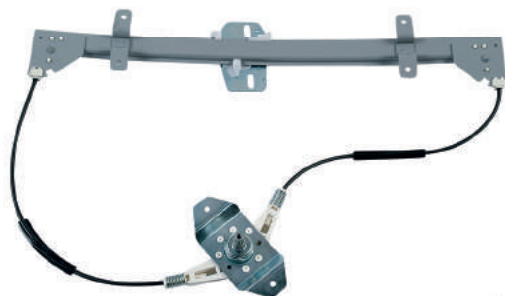

R-4104 E/D
Máquina Reguladora

Gol GII / Parati GII 2P 95...2000

Nº Orig. 373.839.501 (LE) / 373.839.502 (LD)

GOL



R-4105 E/D
Máquina Reguladora

Gol / Saveiro / Voyage / Parati 2P ...87 Pino baixo

Nº Orig. 305.837.501-4 (LE) / 305.837.502-4 (LD)

GOL

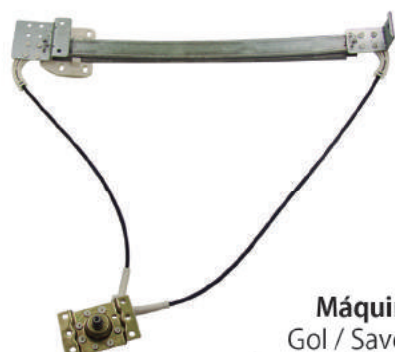

R-4106 E/D
Máquina Reguladora

Gol / Saveiro / Voyage / Parati / 2P 88...94 Pino Alto

Nº Orig. 307.837.501-1 (LE) / 307.837.502-1 (LD)

SEDAN



R-4107 E/D
Máquina Reguladora

Sedan ...70

Nº Orig. 111.837.501ZB (LE) / 111.837.502ZB (LD)

SEDAN



R-4108 E/D
Máquina Reguladora
Sedan 71...

Nº Orig. 113.837.501.1 (LE) / 113.837.502.1 (LD)

VARIANT



R-4109 E/D
Máquina Reguladora
Variant Todas

Nº Orig. 131.837.501.1 (LE) / 131.837.502.1 (LD)

PASSAT



R-4110 E/D
Máquina Reguladora
Passat Todos

Nº Orig. ZBA 837.399 (LE) / ZBA 837.400 (LD)

CAMINHÃO VW

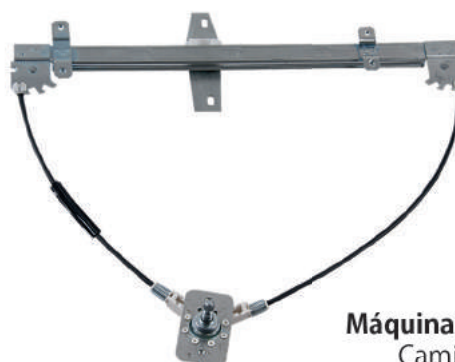

R-4160 E/D
Máquina Reguladora
Caminhão 90...96
Pino Curto C/ Furo

Nº Orig. TF3.837.501 (LE) / TF3.837.502 (LD)

CAMINHÃO VW



R-4161 E/D
Máquina Reguladora
Caminhão 97...2000
Pino Médio C/ Trava

Nº Orig. 2RD 837.501 (LE) / 2RD 837.502 (LD)

CAMINHÃO VW



R-4162 E/D
Máquina Reguladora
Caminhão 80...89
Pino Mais Curto C/ Furo

Nº Orig. TOO 837.501 (LE) / TOO 837.502 (LD)

CAMINHÃO VW



R-4163 E/D
Máquina Reguladora
Caminhão 2001...
Pino Longo C/ Trava

Nº Orig. 2VC.837.501 (LE) / 2VC.837.502 (LD)

SEDAN ALEMÃO



R-4167 E/D
Máquina Reguladora
Sedan Alemão - Exportação

Nº Orig. 111.837.501 H (LE) / 111.837.502 H (LD)

SEDAN MEXICANO



R-4168 E/D
Máquina Reguladora

Sedan Mexicano - Cabo Flocado - Exportação
Nº Orig. 111.837.501. K (LE) / 111.837.502.K (LD)

KOMBI MEXICANA



R-4169 E/D
Máquina Reguladora

Kombi Mexicana - Cabo Flocado - Exportação
Nº Orig. 211.837.501 (LE) / 211.837.502 (LD)

BRASÍLIA



R-4170 E/D
Máquina Reguladora

Brasília Todas
Nº Orig. 102.837.501.1 (LE) / 102.837.502.1 (LD)

KOMBI



R-4171 E/D
Máquina Reguladora

Kombi Clipper 75...2007
Nº Orig. 211.837.501.1 (LE) / 211.837.502.1 (LD)

LOGUS



R-4172 E/D
Máquina Reguladora

Logus / Apolo / Verona 2P 92...96 / Escort 2P 93...96
Nº Orig. 547.837.501-B (LE) / 547.837.502-B (LD)

GOL

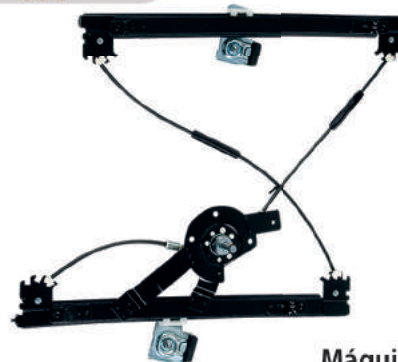

R-4175 E/D
Máquina Reguladora

GOL 4P / Saveiro / Parati 4P GII / GIII / GIV DNT. 98...2007
Nº Orig. 373.837.501 (LE) / 373.837.502 (LD)

GOL



R-4177 E/D
Máquina Reguladora

Gol 4P GII / GIII / GIV 98...2007 TRS.
Nº Orig. 373.839.501 (LE) / 373.839.502 (LD)

SANTANA



R-4184 E/D
Máquina Reguladora

Santana / Quantum / Versailles 2 / 4P DNT. 86...97
Nº Orig. ZBC 837.501.E (LE) / ZBC.837.502.D (LD)

SANTANA

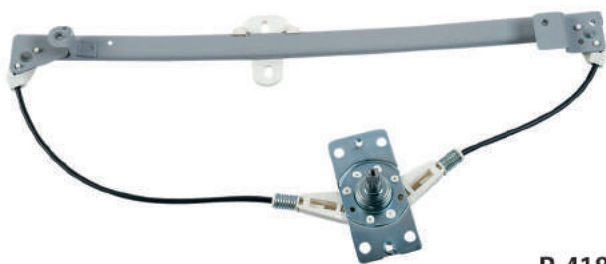

R-4185 E/D
Máquina Reguladora
 Santana / Quantum / Versailles 4P TRS. 86...97
 Nº Orig. ZBD.839.501.E (LE) / ZBC.839.502.D (LD)

SANTANA



R-4186 E/D
Máquina Reguladora
 Santana / Quantum 4P DNT. 98...
 Nº Orig. 327.837.501-2 (LE) / 327.837.502-2 (LD)

SANTANA



R-4187 E/D
Máquina Reguladora
 Santana / Quantum 4P TRS. 98...
 Nº Orig. 327.839.501-8 (LE) / 327.839.502-8 (LD)

CAMINHÃO CONSTELLATION



R-4188 E/D
Máquina Reguladora
 Caminhão Constellation 2005...
 Nº Orig. 2R2.837.397 (LE) / 2R2.837.398 (LD)

SEDAN AMERICANO



R-4197 E/D
Máquina Reguladora
 Sedan Americano - Exportação
 Nº Orig. 0000000000 (LE) / 0000000000 (LD)

SEDAN



C-4200 E/D
Controle da Porta
 Sedan 1200 - 1300 - 1500 ...77
 Nº Orig. 111.837.021.Z (LE) / 111.837.022.Z (LD)

SEDAN

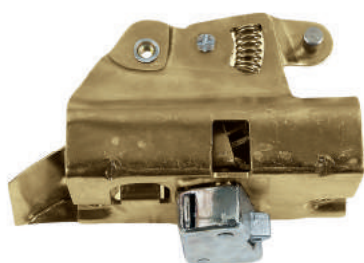

F-4201 E/D
Fechadura
 Sedan 1200 - 1300 - 1500 ...77
 Nº Orig. 111.837.015.Z (LE) / 111.837.016.Z (LD)

KOMBI

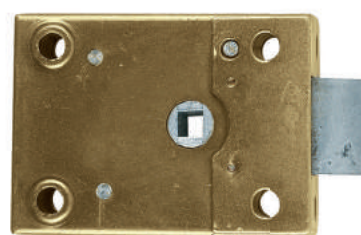

F-4202 T
Fechadura
 Kombi Clipper ...97 (Tampa)
 Nº Orig. 211.829.211.1

SEDAN

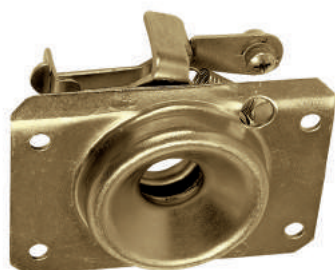

F-4203-I
Fecho de Capô
Sedan 1300-1500 71...81 Inferior
Nº Orig. 113.853.509.1 (Inf.)

SEDAN



F-4203 S
Fecho do Capô
Sedan 1300-1500 71...81 Superior
Nº Orig. 113.823.507 (Sup.)

SEDAN MEXICANO

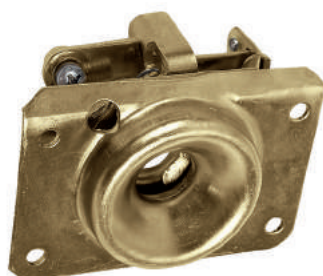

F-4204I
Fecho Inferior
Sedan Mexicano - Exportação
Nº Orig. 152.823.509 B

KOMBI

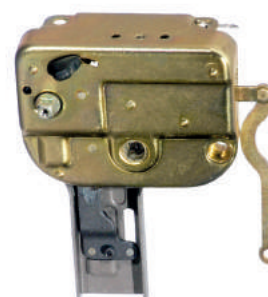

F-4205
Fechadura Porta do Meio C/ Trava
Kombi 98... C/ Maçaneta
Nº Orig. 211.843.654

KOMBI



F-4206 T
Fechadura Tampa Traseira
Kombi Clipper 98...
Nº Orig. 211.829.211

VARIANT

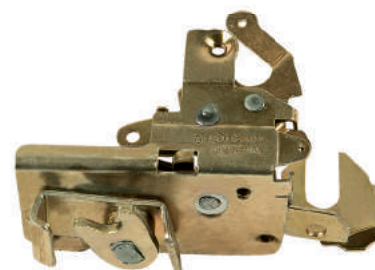

F-4207 E/D
Fechadura
Variant/ Variant II/ Brasília/ Fusca Sedan 79...
Nº Orig. 102.837.015.1 (LE) / 102.837.016.1 (LD)

KOMBI



F-4211
Fechadura Porta Central C/ Trava
Kombi Clipper ... 97
Nº Orig. 211.841.605.1

KOMBI



F-4213
Fechadura Porta do Meio
Kombi Clipper 98... C/ Engate Ling
Nº Orig. 211.843.604J

GOL



R-4392 E/D
Máquina Reguladora
 Gol 4P GV / GVI 2008... DNT.
 Nº Orig. 5U4.837.401 (LE) / 5U4.837.402 (LD)

GOL



R-4393 E/D
Máquina Reguladora
 Gol 4P GV / GVI 2008... TRS.
 Nº Orig. 5U4.839.401.A (LE) / 5U4.839.402.A (LD)

SAVEIRO



R-4394 E/D
Máquina Reguladora
 Saveiro GV 2009...
 Gol 2P 2012...
 Nº Orig. 5U3.837.401 (LE) / 5U3.837.402 (LD)

GOL



F-4395 E/D
Fechadura
 Gol/ Voyage/ Parati/ Saveiro ...85
 Nº Orig. 305.837.015.1 (LE) / 305.837.016.1 (LD)

FOX



R-4396 E/D
Máquina Reguladora
 Fox 2P 2003... Set-2009 Pino Curto
 Nº Orig. 5Z3.837.501E (LE) / 5Z3.837.502E (LD)

FOX

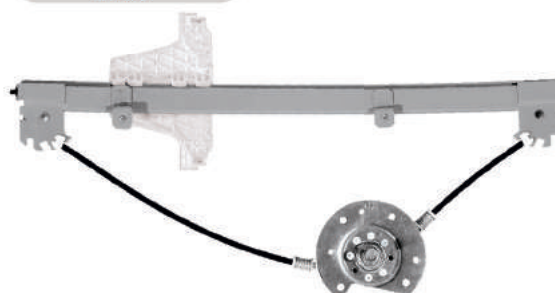

R-4397 E/D
Máquina Reguladora
 Fox 4P DNT. 2003... Set-2009 Pino Curto
 Nº Orig. 5Z4.837.401D (LE) / 5Z4.837.402D (LD)

FOX

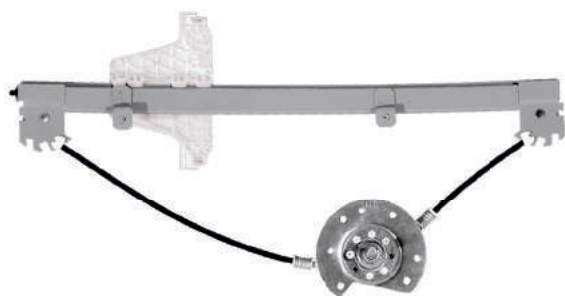

R-4398 E/D
Máquina Reguladora
 Fox 4P TRS. 2003... Set-2009 Pino Curto
 Nº Orig. 5Z4.839.401 (LE) / 5Z4.839.402 (LD)

FOX



R-4399 E/D
Máquina Reguladora
 Fox 2P Out-2009... Pino Longo
 Nº Orig. 5Z3.837.501G (LE) / 5Z3.837.502G (LD)

FOX

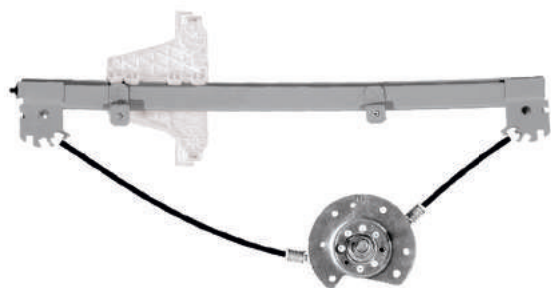

R-4400 E/D
Máquina Reguladora
 Fox 4P DNT. Out-2009... Pino Longo
Nº Orig. 5Z4.837.401G (LE) / 5Z4.837.402G (LD)

SANTANA



F-4493 E/D
Fechadura
 Santana/ Quantum/ 2 /4P DNT. 85...90
Nº Orig. 305.837.015.3 (LE) / 305.837.016.3 (LD)

KOMBI

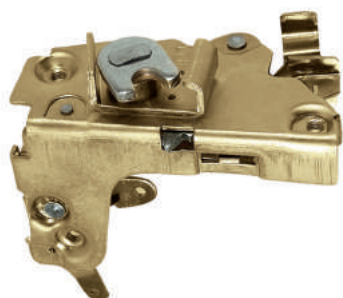

F-4498 E/D
Fechadura Dianteira
 Kombi DNT. / Caminhão Volkswagen Todas
Nº Orig. 231.837.015.1 (LE) / 231.837.016.1 (LD)

GOL



F-4588 E/D
Fechadura
 Gol GII/Parati GII/ Furgão VW 2P 95...00
Nº Orig. 377.837.015 (LE) / 377.837.016 (LD)

FOX

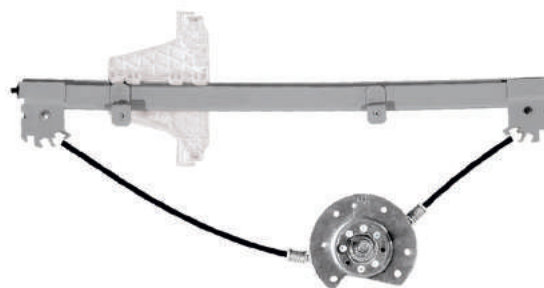

R-4401 E/D
Máquina Reguladora
 Fox 4P TRS. Out-2009... Pino Longo
Nº Orig. 5Z4.839.401D (LE) / 5Z4.839.402D (LD)

SANTANA



F-4495 E/D
Fechadura C/ Trava
 Santana / Quantum 4P TRS. 85...90
Nº Orig. ZBD 839.015 (LE) / ZBD 839.016 (LD)

GOL



F-4587 E/D
Fechadura
 Gol / Voyage / Parati / Saveiro 86...94
Nº Orig. 305.837.015.5 (LE) / 305.837.016.5 (LD)

GOL



F-4589 E/D
Fechadura
 Gol / Parati 4P DNT. / Sav GII e GIII 98...05
Nº Orig. 5X4.837.013 (LE) / 5X4.837.014 (LD)

GOL



F-4590 E/D
Fechadura

Gol 4P / Parati DNT. / Sav GIV 2006...2008
Nº Orig. 5W4.837.013B (LE) / 5W4.837.014B (LD)

GOL

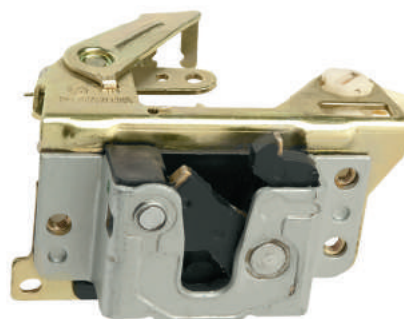

F-4591 E/D
Fechadura

Gol 2P Special GIII / GIV 2001...2011
Nº Orig. 5X3.837.013.999 (LE) / 5X3.837.014.999 (LD)

GOL

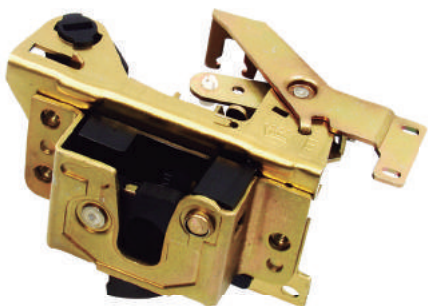

F-4592 E/D
Fechadura

Gol 2P GIII / GIV Mec. / Pré-disposta EL. (Maxion)
Nº Orig. 373.837.013 (LE) / 373.837.014 (LD)

GOL



F-4593 E/D
Fechadura

Gol / Parati 4P GII / Saveiro GII
Nº Orig. 373.837.014.A999 (LE) / 373.837.013.A999 (LD)

GOL

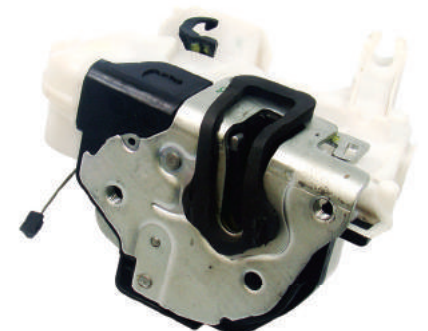

F-4594 E/D
Fechadura

Gol 4P DNT. / Voyage 4P DNT. / Saveiro GV 2008...
Nº Orig. 5U1.837.016Q (LE) / 5U1.837.015Q (LD)

SEDAN



M-41001 E/D
Miolo do Quebra Vento
Sedan

Nº Orig. 111.831.175 (LE) / 111.831.176 (LD)

CORCEL

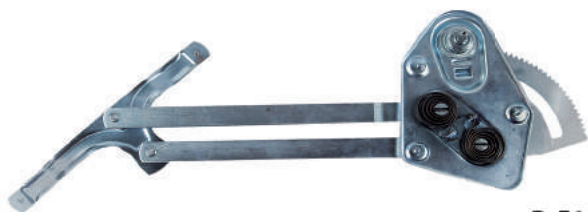

R-5102 E/D
Máquina Reguladora
 Corcel / Belina DNT. 72... 78
Nº Orig. BD5M-542.32.00-A (LE) / BD5M-542.32.01-A (LD)

F 1000 ANTIGA

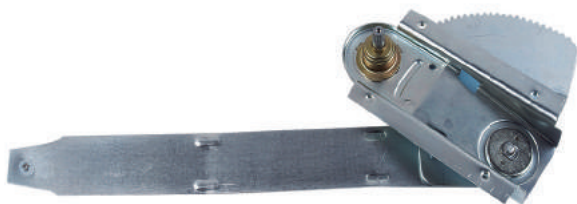

R-5141 E/D
Máquina Reguladora
 Caminhão Ford F1000 72...91
Nº Orig. BD3C.812.3201.A (LE) / BD3C.812.3200.A (LD)

PAMPA



R-5143 E/D
Máquina Reguladora
 Pampa / Del Rey 4P DNT. 81
Nº Orig. 81.EU.542.3201-A (LE) / 81.EU.542.3200-A (LD)

RANGER



R-5146 E/D
Máquina Reguladora
 Ranger DNT. ... 2011
Nº Orig. F37Z.102.3201.A (LE) / F37Z.102.3200.A (LD)

F 1000 MODERNA



R-5149 E/D
Máquina Reguladora
 Caminhão Ford F1000 Ano 92...99 (Sapão)
Nº Orig. T71.837.501.D (LE) / T71.837.502.D (LD)

CORCEL II



R-5140 E/D
Máquina Reguladora
 Corcel II 2P 79...81
Nº Orig. BD8M-622.3201-A (LE) / BD8M-622.3200-A (LD)

DEL REY

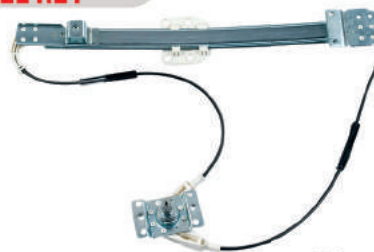

R-5142 E/D
Máquina Reguladora
 Del Rey / Corcel II / Belina II 2P 82...
Nº Orig. 80.NU.622.3201-A (LE) / 80.NU.622.3200-A (LD)

KA

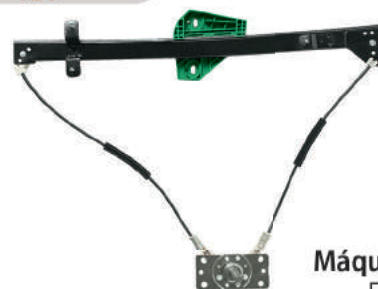

R-5144 E/D
Máquina Reguladora
 Ford Ka 97...2007
Nº Orig. 97KG.B 23201.AF (LE) / 97KG.B 23200.AF (LD)

CARGO



R-5148 E/D
Máquina Reguladora
 Caminhão Ford Cargo 81...
Nº Orig. 81DBE23201AJ (LE) / 81DBE23200AJ (LD)

KA



R-5150 E/D
Máquina Reguladora
 Ford Ka 2008...
Nº Orig. 98KU.B23201.CA (LE) / 98KU.B23200.CA (LD)

RANGER

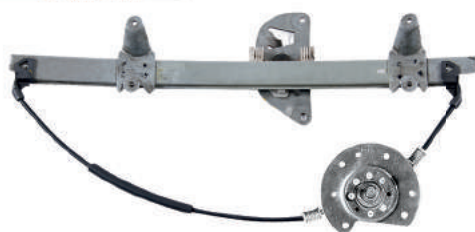

R-5154 E/D
Máquina Reguladora
 Ranger TRS. ...2011
Nº Orig. YL54.352.7001.A (LE) / YL54.352.7000.A (LD)

ESCORT



R-5210 E/D 4D
Máquina Reguladora
 Escort 4P DNT ...86 Pino Curto 4P
Nº Orig. 81ABA-23.201AE (LE) / 81ABA-23.200AE (LD)

ESCORT



R-5215 E/D 4D
Máquina Reguladora
 Escort 4P DNT. 87...92 Pino Longo
Nº Orig. 86ABA-23.201AE (LE) / 86ABA-23.200AE (LD)

FIESTA STREET



R-5220 E/D
Máquina Reguladora
 Fiesta Street 2P 96...2003 / Courier 97...
Nº Orig. 96FGB23.201AC (LE) / 96FGB23.200AC (LD)

PICK-UP FORD 75



R-5223 E/D
Máquina Reguladora
 Pick-up Ford 75... Rural Willis
Nº Orig. BD3B.98231.W01 (LE) / BD3B.98231.W00 (LD)

ESCORT



R-5210 E/D
Máquina Reguladora
 Escort / Hobby 2P/ ...86 Pino Curto
Nº Orig. 81ABB-23.201AF (LE) / 81ABB-23.200AF (LD)

ESCORT



R-5215 E/D
Máquina Reguladora
 Escort / Hobby 2P / 87...92 / Pino Longo
Nº Orig. 86ABB23.201AA (LE) / 86ABB23.200AA (LD)

ESCORT



R-5216 E/D
Máquina Reguladora
 Escort SW-Zetec 4P 97... Pointer / Verona DNT. 93...96
Nº Orig. 95ABA23.202AA (LE) / 95ABA23.201AA (LD)

FIESTA STREET

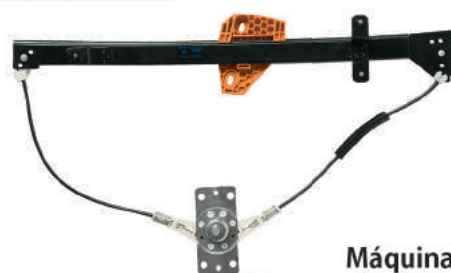

R-5221 E/D
Máquina Reguladora
 Fiesta Street 4P DNT. 96...2003
Nº Orig. 96.FG A23.201AC (LE) / 96.FG A23.200AC (LD)

F-250



R-5226 E/D
Máquina Reguladora
 Caminhão F-250 / F-350 / F-4000 2000...
Nº Orig. XC3Z.252.3201.AA (LE) / XC3Z.252.3200.AA (LD)

LINHA RENAULT



KANGOO

TRAFIC



R-7497 E/D
Máquina Reguladora
Kangoo

Nº Orig. 7700.3035.42 (LE) / 7700.3035.52 (LD)

R-7498 E/D
Máquina Reguladora
Trafic 90...2001

Nº Orig. 7702.0881.22 (LE) / 7702.0881.21 (LD)

LINHA KIA

BESTA

BESTA

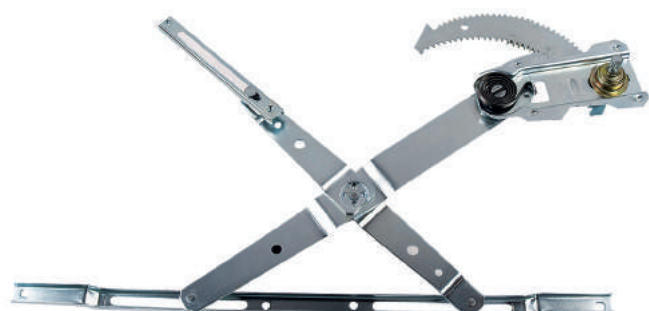

R-7530 E/D
Máquina Reguladora
Besta 2.2 / 2.8 93...98

Nº Orig. OS084.59.560C (LE) / OS084.58.560C (LD)

R-7531 E/D
Máquina Reguladora
Besta GS 98...2005

Orig. OK.72C.59.560A (LE) / OK.72C.58.560A (LD)

CAMINHÃO AGRALE



R-7701 E/D
Máquina Reguladora
Caminhão Agrale
Nº Orig. 000.000.000.000

PICK-UP AGRALE



R-7702 E/D
Máquina Reguladora
Pick-up Agrale
Nº Orig. 000.000.000.000

MARCOPOLO



R-2656 E/D
Máquina Reguladora
Marcopolo
Nº Orig. 000.000.000.000

MARCOPOLO

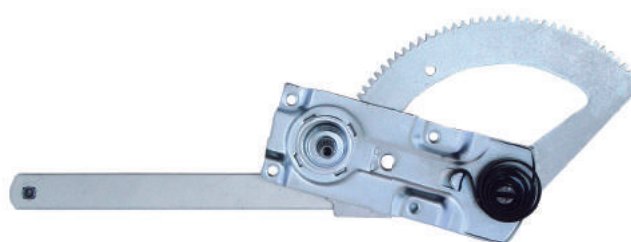

R-2657 E/D
Máquina Reguladora
Marcopolo
Nº Orig. 000.000.000.000

MARCOPOLO



R-2658 E/D
Máquina Reguladora
Marcopolo
Nº Orig. 000.000.000.000



Zinni & Güell Ltda

LINHA
ELÉTRICA

*Máquinas Reguladoras do Vidro Elétricas - Levanta Cristales Eléctricas - Window Lifter Power

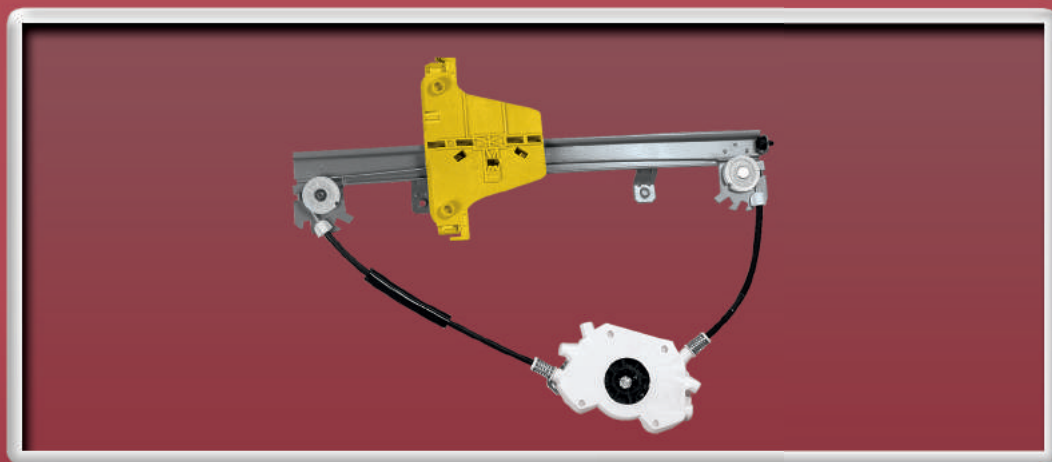
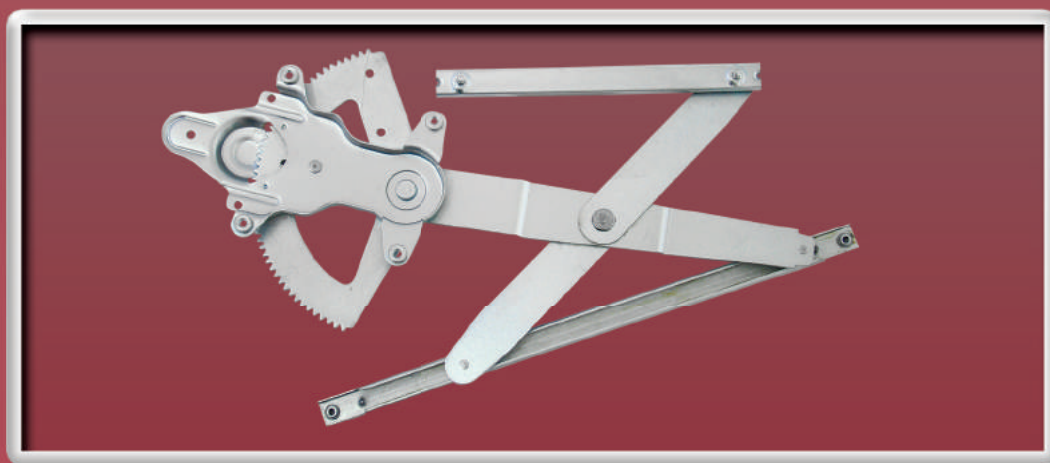
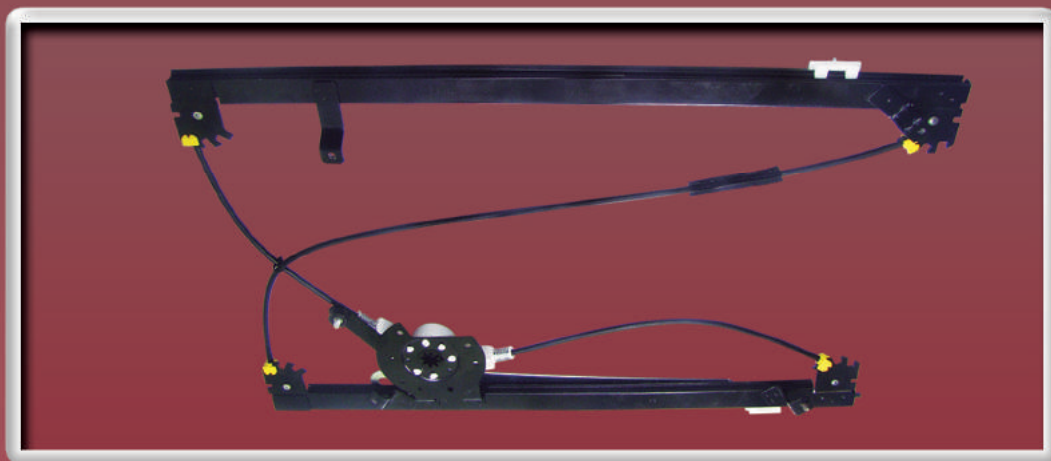

www.zinnieguell.com.br



PUNTO



R-1425 E/D
Máquina Reguladora
 Punto TRS. - Todos
 C/ Motor - S/ Motor - Fixação Motor Mabuchi
Nº Orig. 51.784.091 (LE) / 51.753.953 (LD)

IDEA MOTOR INVERTIDO

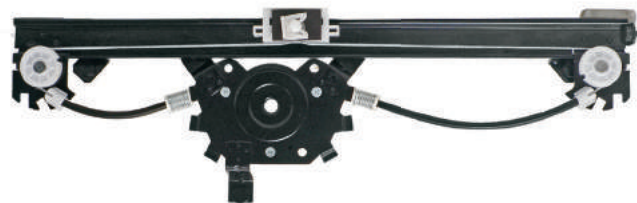

R-1426 E/D
Máquina Reguladora
 Idea TRS. - Todos
 C/ Motor - S/ Motor - Fixação Motor Mabuchi
Nº Orig. 51.783.849 (LE) / 51.783.847 (LD)

UNO MOTOR INVERTIDO



R-1427 E/D
Máquina Reguladora
 Uno 2P 2011...
 C/ Motor - S/ Motor - Fixação Motor Mabuchi
Nº Orig. 51.835.887 (LE) / 51.835.886 (LD)

UNO

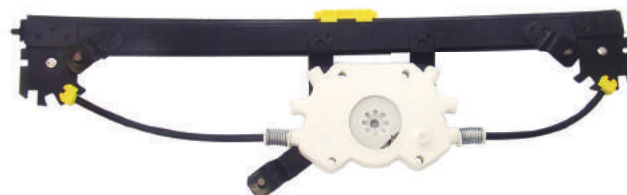

R-1428 E/D
Máquina Reguladora
 Uno 4P DNT. 2010...
 C/ Motor - S/ Motor - Fixação Motor Mabuchi
Nº Orig. 518.358.850 (LE) / 518.358.840 (LD)

UNO MOTOR INVERTIDO

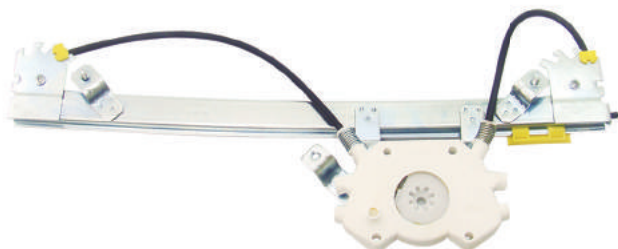

R-1429 E/D
Máquina Reguladora
 Uno 4P TRS. 2010...
 C/ Motor - S/ Motor - Fixação Motor Mabuchi
Nº Orig. 518.358.880 (LE) / 518.358.879 (LD)

UNO



R-1430 E/D
Máquina Reguladora
 Uno / Prêmio / Elba 2P 84...
 C/ Motor - S/ Motor
 Fixação Motor Mabuchi
Nº Orig. 7.523.661 (LE) / 7.523.662 (LD)

UNO MOTOR INVERTIDO



R-1431 E/D
Máquina Reguladora
 Uno / Prêmio / Elba 4P DNT. / Fiorino 84...
 C/ Motor - S/ Motor - Fixação Motor Mabuchi
Nº Orig. 7.524.176 (LE) / 7.524.175 (LD)

UCATO



R-1432 E/D
Máquina Reguladora
 Ducato 99.../ Boxer 2000... Jumper 2007...
 C/ Motor - S/ Motor - Fixação Motor Mabuchi
Nº Orig. 1.341.396.080 (LE) / 1.341.395.080 (LD)

TEMPRA MOTOR INVERTIDO



R-1433 E/D
Máquina Reguladora
 Tempra 4P DNT.
 C/ Motor - S/ Motor - Fixação Motor Mabuchi
Nº Orig. 50.004.956 SM (LE) / 50.004.955 SM (LD)

PALIO MOTOR INVERTIDO

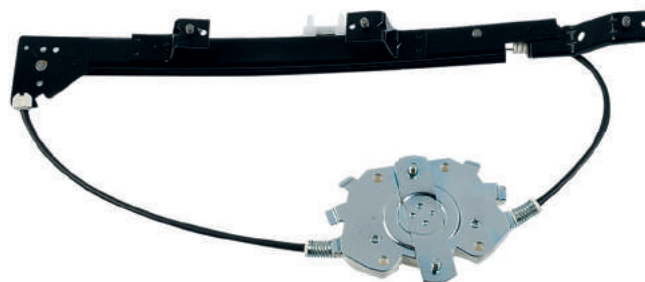

R-1434 E/D
Máquina Reguladora
 Palio / Siena 96...2011 Weekend 4P TRS. 96...
 C/ Motor - S/ Motor - Fixação Motor Mabuchi
Nº Orig. 46.446.911 (LE) / 46.446.910 (LD)

PALIO

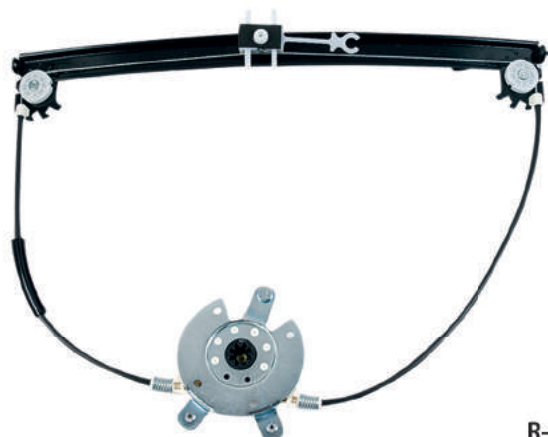

R-1435 E/D
Máquina Reguladora
 Palio 2P / Pick-Up Strada 96...
 C/ Motor - S/ Motor - Fixação Motor Mabuchi
Nº Orig. 46.736.840 (LE) / 46.736.841 (LD)

PALIO MOTOR INVERTIDO



R-1436 E/D
Máquina Reguladora
 Palio / Siena 96...2011 Weekend 4P DNT. 96...
 C/ Motor - S/ Motor - Fixação Motor Mabuchi
Nº Orig. 46.736.843 (LE) / 46.736.842 (LD)

DOBLÔ MOTOR INVERTIDO



R-1443 E/D
Máquina Reguladora
 Fiat Doblô 2002...
 C/ Motor - S/ Motor - Fixação Motor Mabuchi
Nº Orig. 51.720.131 LE / 51.720.132 LD

IVECO STRALIS



R-1445 E/D
Máquina Reguladora
 Iveco Stralis / Eurocargo / Tector /
 Cavallino 320 Todos 98... 24V
 C/ Motor - S/ Motor - Fixação Motor Mabuchi
Nº Orig. 2.997.196LH (LE) / 2.997.195RH (LD)

PALIO MOTOR INVERTIDO



R-1447 E/D
Máquina Reguladora
 Palio 4P DNT. 2012...
 C/ Motor - S/ Motor - Fixação Motor Mabuchi
Nº Orig. 51.849.101 (LE) / 51.849.097 (LD)

IVECO DAILY



R-1449 E/D
Máquina Reguladora
 Iveco Daily 35S14/40S16/55S14/70C16/ Master ...2007 12V
 C/ Motor - S/ Motor - Fixação Motor Mabuchi
Nº Orig. 4.856.369 (LE) / 4.856.368 (LD)

IVECO DAILY



R-1444 E/D
Máquina Reguladora
 Iveco Daily 35S14/40S16/55S14/ 70C16/ Master 2008...2013 / 12 V
 C/ Motor - S/ Motor - Fixação Motor Mabuchi
Nº Orig. 504.173.868 (LE) / 504.173.869 (LD)

IVECO VERTIS



R-1446 E/D
Máquina Reguladora
 Iveco Vertis 2011... 12/24V
 C/ Motor - S/ Motor - Fixação Motor Mabuchi
Nº Orig. 594.989.11.65 (LE) / 594.989.11.64 (LD)

PALIO



R-1448 E/D
Máquina Reguladora
 Palio 4P TRS. 2012...
 C/ Motor - S/ Motor - Fixação Motor Mabuchi
Nº Orig. 51.849.110 (LE) / 51.849.106 (LD)

IVECO DAILY

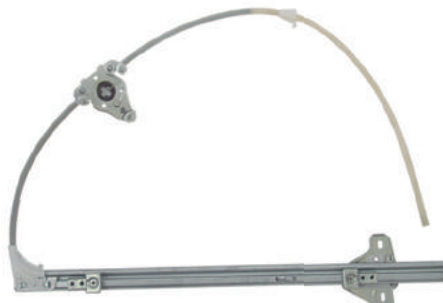

R-1450 E/D
Máquina Reguladora
 Iveco Daily 35S14/ 40S16/ 55S14 2008... Master 2008...
 Somente sem Motor - Fixação Motor Original
Nº Orig. 504.173.868 (LE) / 504.173.869 (LD)

HPN

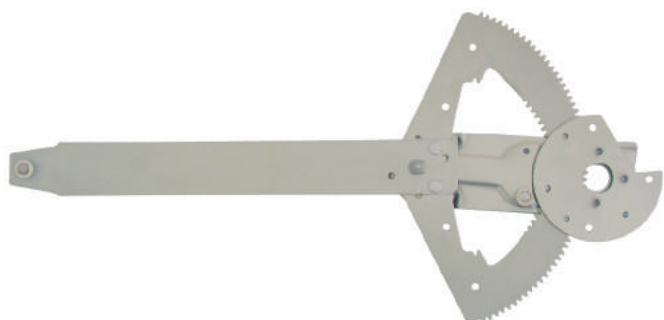

R-2126 E/D
Máquina Reguladora
 Caminhão Mercedes Benz 709/1935 91...2000 12V / 24 Volts
 C/ Motor - S/ Motor - Fixação Motor Mabuchi
Nº Orig. A384.720.70.46 (LE) / A384.720.71.46 (LD)

HPN



R-2128 E/D
Máquina Reguladora
 Caminhão Mercedes Benz 709/1935 2001... 12V / 24 Volts
 C/ Motor - S/ Motor - Fixação Motor Mabuchi
Nº Orig. 696.720.02.46 SM (LE) / 696.720.01.46 SM (LD) 12 Volts
 696.720.04.46 (LE) / 696.720.05.46 (LD) 24 Volts

ATEGO

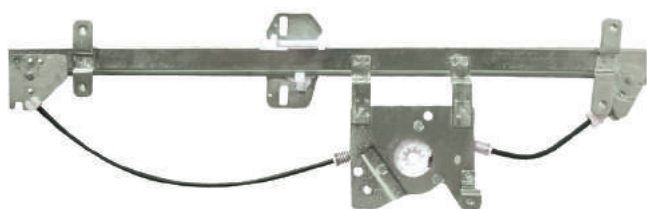

R-2310 E/D
Máquina Reguladora
 Caminhão Mercedes Benz 1938S/ Atego/ Axor/ Actros 97... 24V
 Somente sem Motor - Fixação Motor Original
Nº Orig. 973.720.03.46 (LE) / 973.720.04.46 (LD)

ACCELO MOTOR INVERTIDO

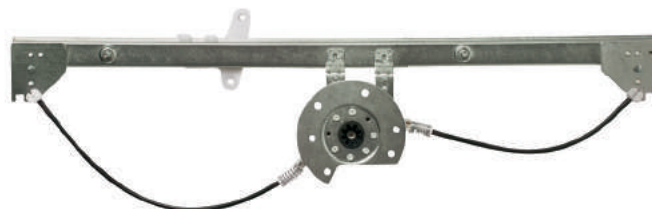

R-2311 E/D
Máquina Reguladora
 Caminhão Mercedes Benz Accelo 715 - 12V / 915 - 24V ...2011
 C/ Motor - S/ Motor - Fixação Motor Mabuchi
Nº Orig. Cam. 715 - 979.720.01.46 SM (LE) / 979.720.02.46 SM (LD) 12 Volts
 Cam. 915 - 979.720.70.46 SM (LE) / 979.720.71.46 SM (LD) 24 Volts

ATEGO MOTOR INVERTIDO

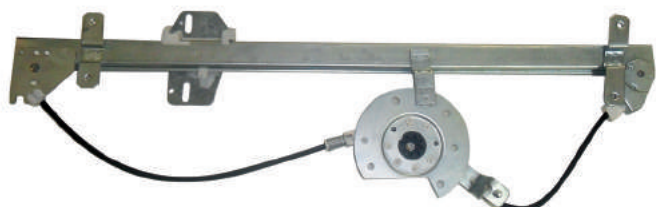

R-2312 E/D
Máquina Reguladora
 Caminhão Mercedes Benz 1938S/Atego/Axor/
 Actros 97/... 24V - C/ Motor - S/ Motor - Fixação Motor Mabuchi
Nº Orig. 973.720.03.46 (LE) / 973.720.04.46 (LD)

ACCELO MOTOR INVERTIDO

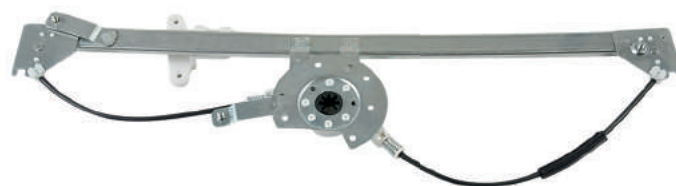

R-2313 E/D
Máquina Reguladora
 Caminhão Mercedes Benz Accelo 815/1016 2012... 12/24 Volts
 C/ Motor - S/ Motor - Fixação Motor Mabuchi
Nº Orig. 979.720.08.46 (LE) / 979.720.09.46 (LD)

LINHA SCANIA



SÉRIE 4

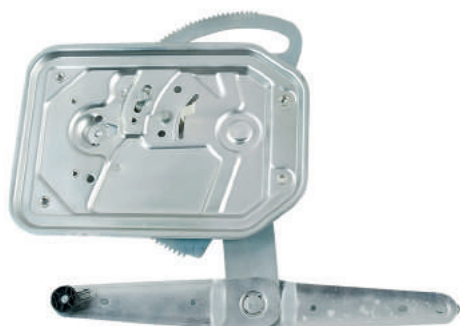

R-2607 E/D
Máquina Reguladora
Caminhão Scania Série 4 114 / 124 / T/R 98...
C/ Motor - S/ Motor - Fixação Motor Original
Nº Orig. 1.442.294 SM (LE) / 1.442.295 SM (LD)

SÉRIE 3



R-2608 E/D
Máquina Reguladora
Caminhão Scania Série 3 / R112 / R113 / T112 / T113 81...97
C/ Motor - S/ Motor - Fixação Motor Original
Nº Orig. 376.673 (LE) / 376.674 (LD)

LINHA VOLVO

NL 10

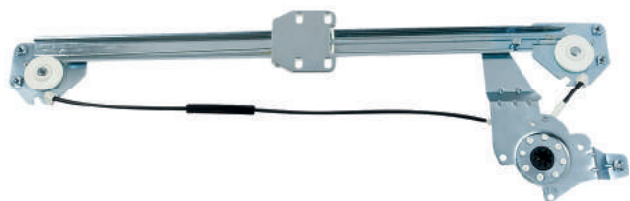

R-2613 E/D
Máquina Reguladora
Caminhão Volvo NL10/ NL12 90...94 Cabine Longa 24 Volts
C/ Motor - S/ Motor - Fixação Motor Mabuchi
Nº Orig. 8.123.551 (LE) / 8.123.550 (LD)

VM

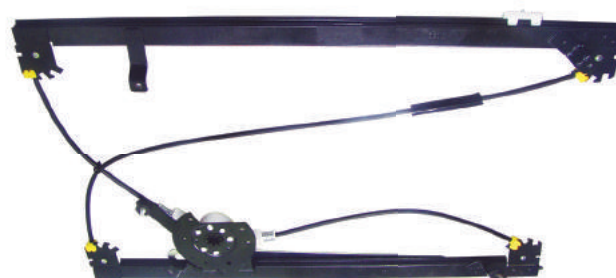

R-2614 E/D
Máquina Reguladora
Caminhão Volvo VM 2004... Todos
C/ Motor - S/ Motor - Fixação Motor Mabuchi -12/24 Volts
Nº Orig. 20.557.552 (LE) / 20.557.554 (LD)

FH / FM

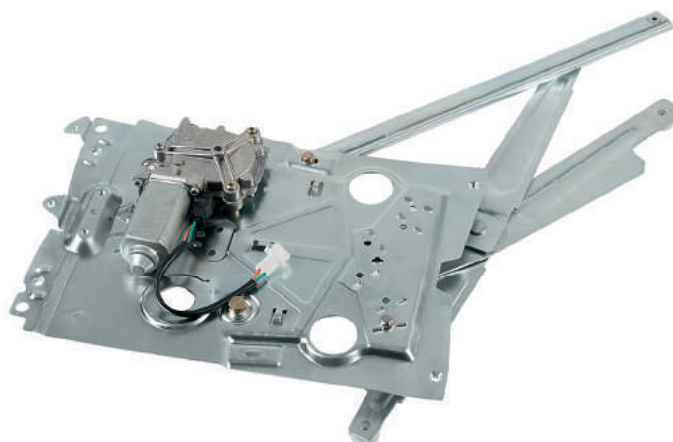

R-2615 E/D
Máquina Reguladora
Caminhão Volvo FH12 / FH13 / FM 94...
C/ Motor - S/ Motor - Fixação Motor Original - Todos 24V
Nº Orig. 3.176.545 (LE) / 3.176.546 (LD)

KADETT MOTOR INVERTIDO

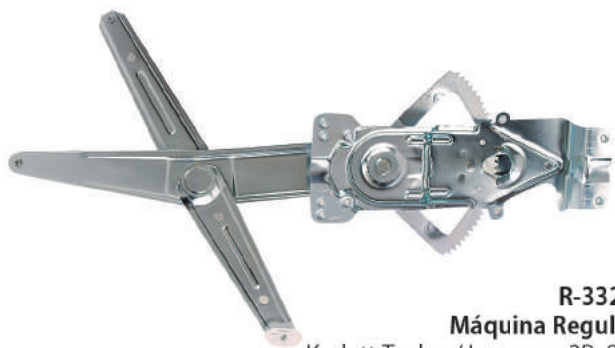

R-3323 E/D
Máquina Reguladora
 Kadett Todos / Ipanema 2P 89...98
 C/ Motor - S/ Motor - Fixação Motor Mabuchi
Nº Orig. 52.280.829 (LE) / 52.280.830 (LD)

CELTA MOTOR INVERTIDO

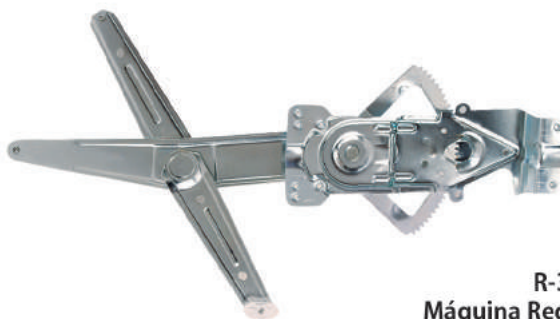

R-3325 E/D
Máquina Reguladora
 Celta 2P 2000...
 C/ Motor - S/ Motor - Fixação Motor Mabuchi
Nº Orig. 93.361.653 (LE) / 93.361.654 (LD)

CELTA MOTOR INVERTIDO



R-3326 E/D
Máquina Reguladora
 Celta 4P DNT. 2003... Prisma 4P DNT. 2006...2012
 C/ Motor - S/ Motor - Fixação Motor Mabuchi
Nº Orig. 93.324.533 (LE) / 93.324.534 (LD)

CORSA MOTOR INVERTIDO



R-3327 E/D
Máquina Reguladora
 Corsa 4P DNT. 2002...2012 / Montana ...2010
 C/ Motor - S/ Motor - Fixação Motor Mabuchi
Nº Orig. 93.264.209 (LE) / 93.264.210 (LD)

CORSA



R-3328 E/D
Máquina Reguladora
 Corsa 4P TRS. 2002...2012
 C/ Motor - S/ Motor - Fixação Motor Mabuchi
Nº Orig. 93.264.213 (LE) / 93.264.214 (LD)

MONZA MOTOR INVERTIDO



R-3329 E/D
Máquina Reguladora
 Monza 4P DNT. 84...96
 C/ Motor - S/ Motor - Fixação Motor Mabuchi
Nº Orig. 52.255.181 (LE) / 52.255.182 (LD)

MONZA



R-3330 E/D
Máquina Reguladora
 Monza 2P 83...96 Somente sem Motor - Fixação Motor Carto
Nº Orig. 94.649.143 (LE) / 94.649.144 (LD)

MONZA MOTOR INVERTIDO



R-3331 E/D
Máquina Reguladora
 Monza 2P 83...96 C/ Motor - S/ Motor - Fixação Motor Mabuchi
Nº Orig. 94.649.143 (LE) / 94.649.144 (LD)

D20 MOTOR INVERTIDO



R-3332 E/D
Máquina Reguladora
 D20 /Bonanza /Veraneio 91... DNT.
 C/ Motor - S/ Motor - Fixação Motor Mabuchi
Nº Orig. 52.255.123 (LE) / 52.255.124 (LD)

D20

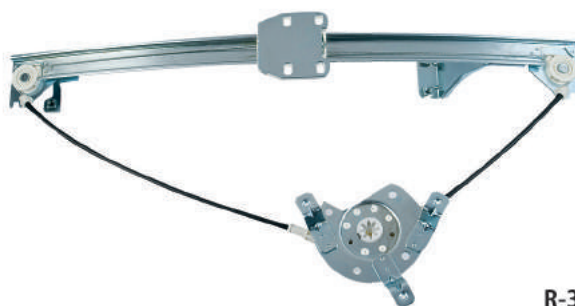

R-3333 E/D
Máquina Reguladora
 D20 / Bonanza / Veraneio 91... TRS.
 C/ Motor - S/ Motor - Fixação Motor Mabuchi
Nº Orig. 52.255.127 (LE) / 52.255.128 (LD)

AGILE



R-3334 E/D
Máquina Reguladora
 Agile 4P DNT. 2009... Montana 2011...
 C/ Motor - S/ Motor - Fixação Motor Mabuchi
Nº Orig. 94.704.761 (LE) / 94.704.762 (LD)

AGILE MOTOR INVERTIDO

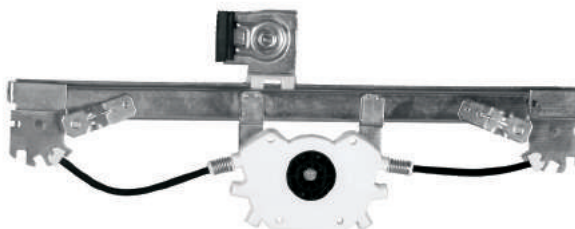

R-3335 E/D
Máquina Reguladora
 Agile 4P TRS. 2009...
 C/ Motor - S/ Motor - Fixação Motor Mabuchi
Nº Orig. 94.700.279 (LE) / 94.700.280 (LD)

CORSA MOTOR INVERTIDO



R-3340 E/D
Máquina Reguladora
 Corsa 2P / Pick-Up Corsa ... 2001
 C/ Motor - S/ Motor - Fixação Motor Mabuchi
Nº Orig. 93.334.693 (LE) / 93.334.692 (LD)

CORSA MOTOR INVERTIDO

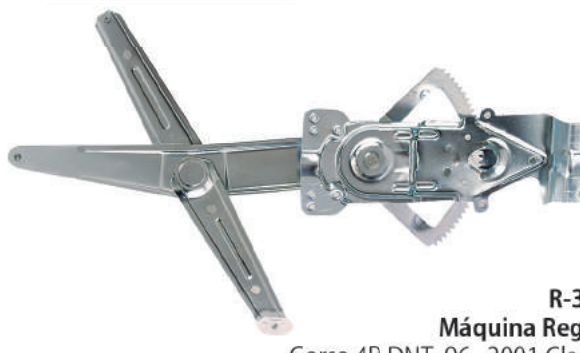

R-3341 E/D
Máquina Reguladora
 Corsa 4P DNT. 96...2001 Classic 96...
 C/ Motor - S/ Motor - Fixação Motor Mabuchi
Nº Orig. 93.334.689 (LE) / 93.334.688 (LD)

S10 MOTOR INVERTIDO



R-3344 E/D
Máquina Reguladora
 S10 / Blazer 4P DNT. 95...2011
 C/ Motor - S/ Motor - Fixação Motor Mabuchi
Orig. 15.705.143 (LE) / 15.705.144 (LD)

CORSA MOTOR INVERTIDO

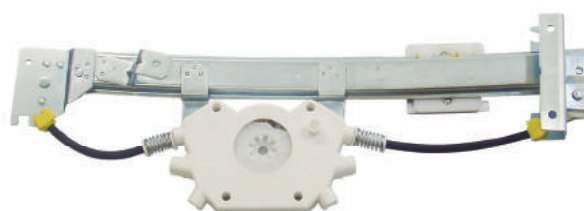

R-3349 E/D
Máquina Reguladora
 Corsa Classic 4P TRS. 96...
 C/ Motor - S/ Motor - Fixação Motor Mabuchi
Nº Orig. 93.253.441 (LE) / 93.253.442 (LD)

CELTA MOTOR INVERTIDO



R-3351 E/D
Máquina Reguladora
 Celta 4P TRS. 2003... Prisma 4P TRS ...2012
 C/ Motor - S/ Motor - Fixação Motor Mabuchi
Nº Orig. 93.363.859 EL (LE) / 93.363.860 EL (LD)

COBALT



R-3352 E/D
Máquina Reguladora
 Cobalt 4P DNT. 2012...
 C/ Motor - S/ Motor - Fixação Motor Mabuchi
Nº Orig. 94.773.653 (LE) / 94.773.654 (LD)

COBALT

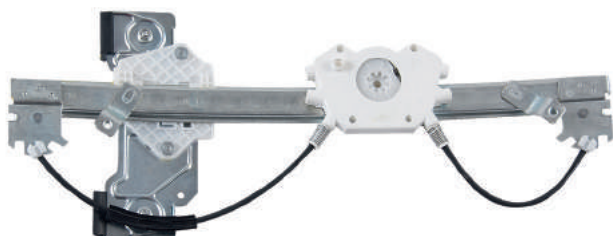

R-3353 E/D
Máquina Reguladora
 Cobalt 4P TRS. 2012...
 C/ Motor - S/ Motor - Fixação Motor Mabuchi
Nº Orig. 94.773.649 (LE) / 94.773.650 (LD)

S 10



R-3357 E/D
Máquina Reguladora
 S10 Nova 4P 2012... DNT.
 C/ Motor - S/ Motor - Fixação Motor Mabuchi
Nº Orig. 947.736.649 (LE) / 947.736.650 (LD)

S 10 MOTOR INVERTIDO



R-3358 E/D
Máquina Reguladora
 S10 Nova 4P 2012... TRS
 C/ Motor - S/ Motor - Fixação Motor Mabuchi
Nº Orig. 05.483.148 (LE) / 05.483.149 (LD)

ONIX

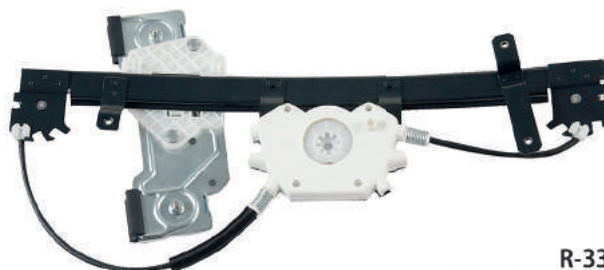

R-3359 E/D
Máquina Reguladora
 Onix 4P DNT. 2012... Prisma 2013...
 C/ Motor - S/ Motor - Fixação Motor Mabuchi
Nº Orig. 52.039.029 (LE) / 52.039.028 (LD)

ONIX

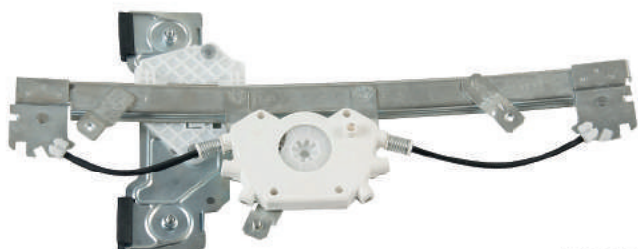

R-3360 E/D
Máquina Reguladora
 Onix 4P TRS. 2012... Prisma 2013...
 C/ Motor - S/ Motor - Fixação Motor Mabuchi
Orig. 52.039.026 (LE) / 52.039.027 (LD)

SPIN



R-3361 E/D
Máquina Reguladora
 Spin 4P DNT. 2012...
 C/ Motor - S/ Motor - Fixação Motor Mabuchi
Nº Orig. 52.021.151 (LE) / 52.021.149 (LD)

SPIN

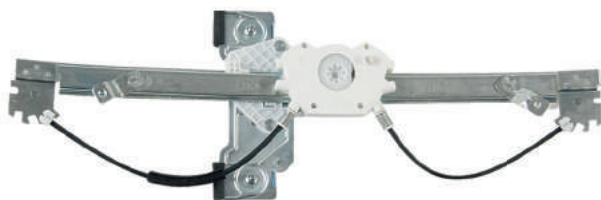

R-3362 E/D
Máquina Reguladora
 Spin 4P TRS. 2012...
 C/ Motor - S/ Motor - Fixação Motor Mabuchi
Nº Orig. 52.211.164 (LE) / 52.211.166 (LD)

S 10

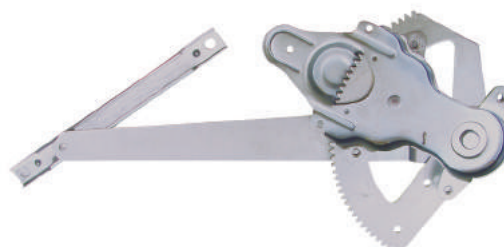

R-3363 E/D
Máquina Reguladora
 S10 4P TRS. 2012... Especial (O vidro desce até o final do curso)
 C/ Motor - S/ Motor - Fixação Motor Mabuchi
Nº Orig. 05.483.148 (LE) / 05.483.149 (LD)

VECTRA

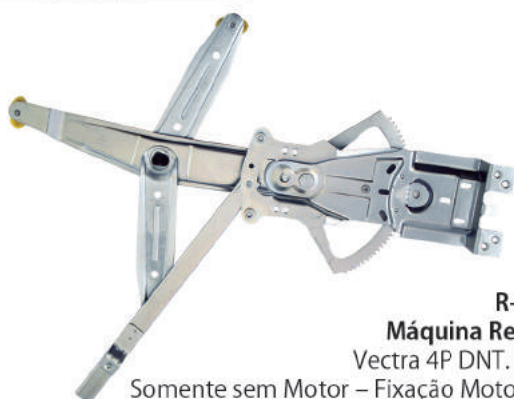

R-3364 E/D
Máquina Reguladora
 Vectra 4P DNT. 96...2004
 Somente sem Motor - Fixação Motor Original
Nº Orig. 93.329.516 (LE) / 93.329.517 (LD)

VECTRA

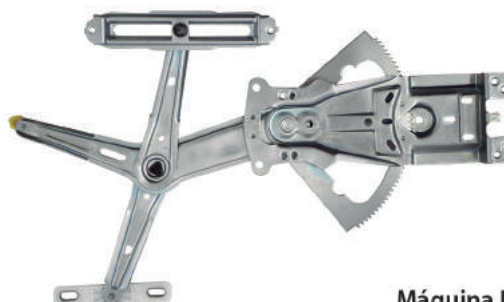

R-3365 E/D
Máquina Reguladora
 Vectra 4P DNT. 2005...2013
 Somente sem Motor - Fixação Motor Original
Nº Orig. 93.306.468 (LE) / 93.306.469 (LD)

ASTRA

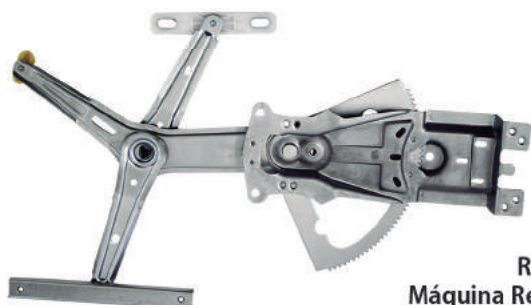

R-3366 E/D
Máquina Reguladora
 Astra Hatch/ Sedan 2/4P DNT. 98...2002
 Somente sem Motor - Fixação Motor Original
Nº Orig. 93.255.063 / 93.326.107 (LE)
 93.255.064 / 93.326.106 (LD)

CELTA 2P 8 DENTES

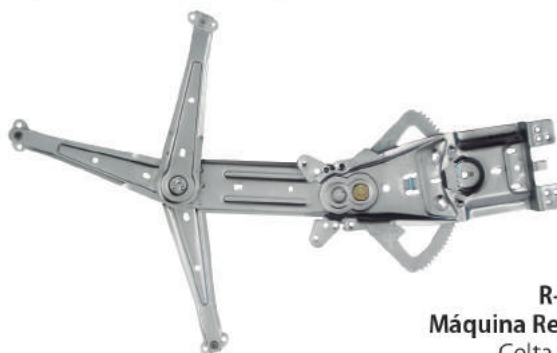

R-3370 E/D
Máquina Reguladora
 Celta 2P 2000...
 Somente sem Motor - Fixação Motor Original 8 Dentes - Inteligente
Nº Orig. 93.361.653 SM (LE) / 93.361.654 SM (LD)

CELTA 4P 8 DENTES



R-3371 E/D
Máquina Reguladora
 Celta 4P DNT. 2003.../ Prisma 4P DNT. 2006...2012
 Somente sem Motor - Fixação Motor Original 8 Dentes - Inteligente
Nº Orig. 93.324.533 SM (LE) / 93.324.534 SM (LD)

CORSA 2P 8 DENTES



R-3372 E/D
Máquina Reguladora
 Corsa 2P / Pick-up Corsa ...2001
 Somente sem Motor - Fixação Motor Original 8 Dentes - Inteligente
Nº Orig. 93.334.693 SM (LE) / 93.334.692 SM (LD)

CORSA 4P 8 DENTES

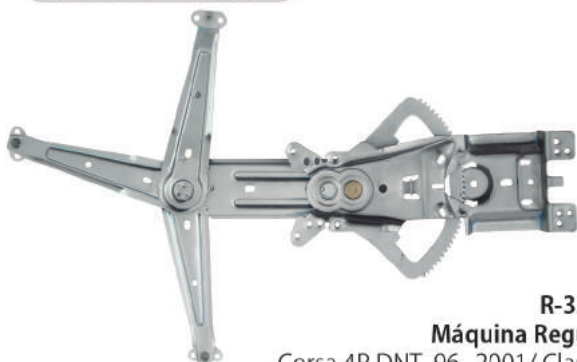

R-3373 E/D
Máquina Reguladora
 Corsa 4P DNT. 96...2001/ Classic 96...
 Somente sem Motor- Fixação Motor Original 8 Dentes - Inteligente
Nº Orig. 93.334.689 SM (LE) / 93.334.688 SM (LD)

MONTANA 8 DENTES

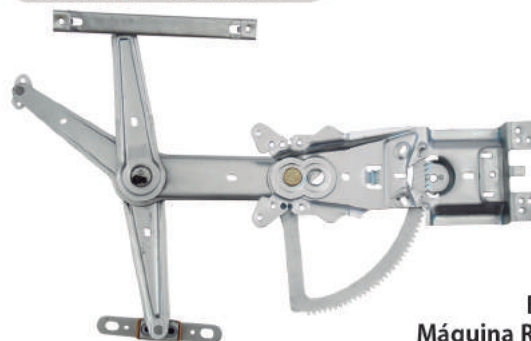

R-3374 E/D
Máquina Reguladora
 Corsa 4P DNT. 2002...2012/ Montana ...2010
 Somente sem Motor- Fixação Motor Original 8 Dentes - Inteligente
Nº Orig. 93.264.209 SM (LE) / 93.264.210 SM (LD)

ZAFIRA 10 DENTES

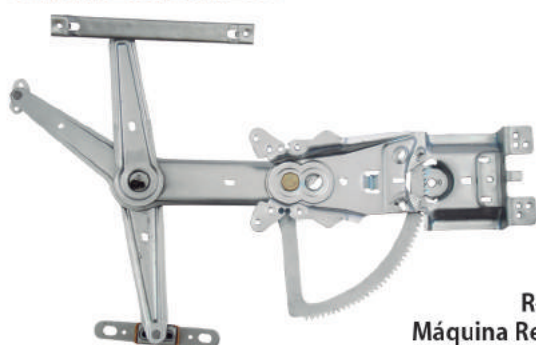

R-3375 E/D
Máquina Reguladora
 Zafira 4P. DNT. Abr-2001...2012
 Somente sem Motor- Fixação Motor Original 10 Dentes
Nº Orig. 93.281.521 SM (LE) / 93.281.522 SM (LD)

CELTA 2P 10 DENTES

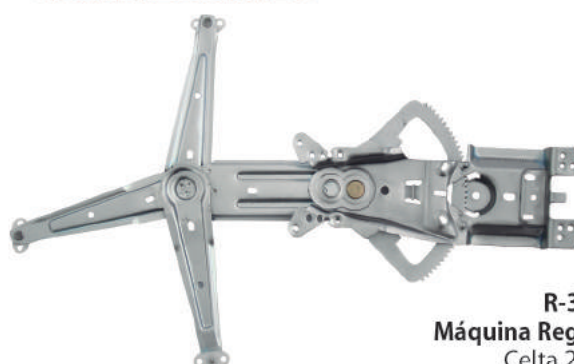

R-3376 E/D
Máquina Reguladora
 Celta 2P 2000...
 Somente sem Motor- Fixação Motor Original 10 Dentes - Inteligente
Nº Orig. 93.361.653 SM (LE) / 93.361.654 SM (LD)

CELTA 4P 10 DENTES

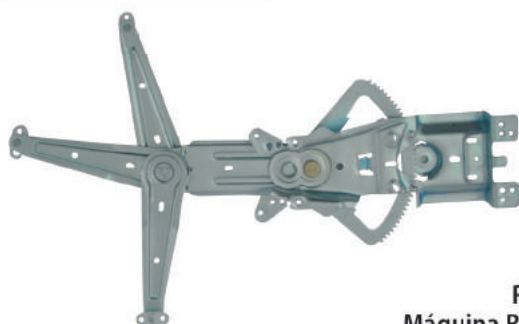

R-3377 E/D
Máquina Reguladora
 Celta 4P DNT. 2003.../ Prisma 4P DNT. 2006...2012
 Somente sem Motor- Fixação Motor Original 10 Dentes - Inteligente
Nº Orig. 93.324.533 SM (LE) / 93.324.534 SM (LD)

CORSA 4P 10 DENTES

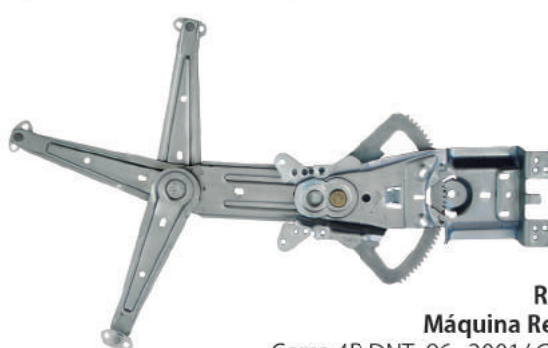

R-3378 E/D
Máquina Reguladora
 Corsa 4P DNT. 96...2001/ Classic 96...
 Somente sem Motor- Fixação Motor Original 10 Dentes - Inteligente
Nº Orig. 93.334.689 SM (LE) / 93.334.688 SM (LD)

CORSA 4P 10 DENTES

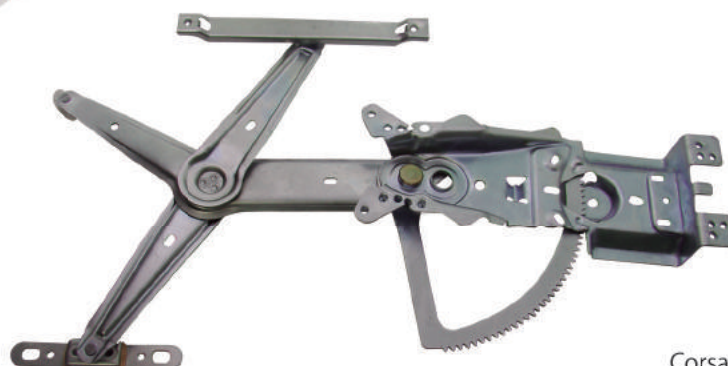

R-3379 E/D
Máquina Reguladora
 Corsa 4P DNT. 2002...2012/ Montana ...2010
 Somente sem Motor- Fixação Motor Original 10 Dentes - Inteligente
Nº Orig. 93.264.209 SM (LE) / 93.264.210 SM (LD)

UP

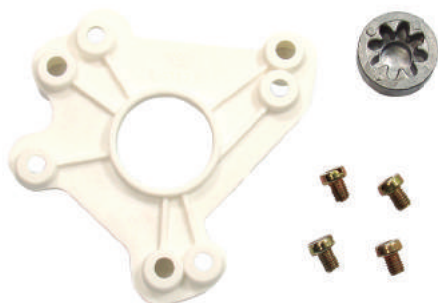

R-4117 E/D
Reparo

Reparo P/ Máquina Reg. UP 4P DNT. 2014...
C/ Motor - S/ Motor - Fixação Motor Mabuchi
Nº Orig. 6RU.959.802 (LE) / 6RU.959.801 (LD)

UP



R-4118 E/D
Máquina Reguladora

UP 4P TRS. 2014...
C/ Motor - S/ Motor - Fixação Motor Mabuchi
Nº Orig. 1SD.839.461A (LE) / 1SD.839.462A (LD)

PASSAT



R-4119 E/D
Máquina Reguladora

Passat Todos
C/ Motor - S/ Motor - Fixação Motor Mabuchi
Nº Orig. ZBA 837.399 (LE) / ZBA 837.400 (LD)

SEDAN MOTOR INVERTIDO



R-4120 E/D
Máquina Reguladora

Sedan Todos
C/ Motor - S/ Motor Fixação Motor Mabuchi
Nº Orig. 113.837.501.1 (LE) / 113.837.502.1 (LD)

GOL



R-4129 E/D
Máquina Reguladora

Gol Special 2P G III / GIV 2001...2011
C/ Motor - S/ Motor - Fixação Motor Mabuchi
Nº Orig. 5XO.837.501-A (LE) / 5XO.837.502-A (LD)

GOL



R-4130 E/D
Máquina Reguladora

Gol/ Voyage /Parati 2P / Saveiro ...94
Somente sem Motor - Fixação Motor Carto
Nº Orig. 305.837.501.5 (LE) / 305.837.502.5 (LD)

GOL



R-4131 E/D
Máquina Reguladora

Gol / Voyage / Parati 2P / Saveiro ...94
C/ Motor - S/ Motor - Fixação Motor Mabuchi
Nº Orig. 305.837.501.5 (LE) / 305.837.502.5 (LD)

GOL



R-4132 E/D
Máquina Reguladora

Gol 2P GII 95...2000
C/ Motor - S/ Motor - Fixação Motor Mabuchi
Nº Orig. 377.837.501-A (LE) / 377.837.502-A (LD)

GOL

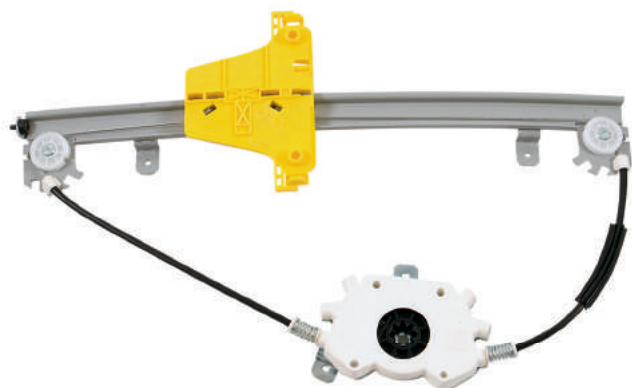

R-4133 E/D
Máquina Reguladora
 Gol 4P / Voyage 4P GV / GVI DNT. 2008...
 C/ Motor - S/ Motor Fixação Motor Mabuchi
 Nº Orig. 5U4.837.399 (LE) / 5U4.837.400 (LD)

GOL



R-4134 E/D
Máquina Reguladora
 Gol 4P / Voyage 4P GV / GVI TRS. 2008...
 C/ Motor - S/ Motor - Fixação Motor Mabuchi
 Nº Orig. 5U4.839.399A (LE) / 5U4.839.400A (LD)

SAVEIRO



R-4135 E/D
Máquina Reguladora
 Saveiro GV 2009... Gol 2P GV 2012...
 C/ Motor - S/ Motor - Fixação Motor Mabuchi
 Nº Orig. 5U3.837.399 (LE) / 5U3.837.400 (LD)

GOL



R-4136 E/D
Máquina Reguladora
 Gol 4P/Voyage 4P GV / GVI DNT. 2008...
 Somente sem Motor - Fixação Motor Original
 Nº Orig. 5U4.837.399 (LE) / 5U4.837.400 (LD)

GOL



R-4137 E/D
Máquina Reguladora
 Gol 4P/Voyage 4P GV / GVI / TRS. 2008...
 Somente sem Motor - Fixação Motor Original
 Nº Orig. 5U4.839.399A (LE) / 5U4.839.400A (LD)

SAVEIRO



R-4138 E/D
Máquina Reguladora
 Saveiro GV 2009... Gol 2P GV 2012...
 Somente sem Motor - Fixação Motor Original
 Nº Orig. 5U3.837.399 (LE) / 5U3.837.400 (LD)

LOGUS



R-4173 E/D
Máquina Reguladora
 Logus / Verona / Apolo 2P 92...96
 C/ Motor - S/ Motor - Fixação Motor Mabuchi
 Nº Orig. 547.837.501-D (LE) / 547.837.502-D (LD)

GOL MOTOR INVERTIDO

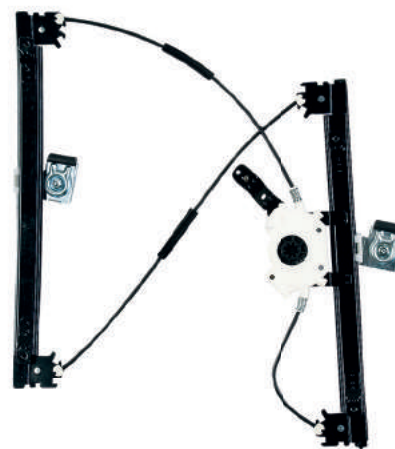

R-4174 E/D
Máquina Reguladora
 Gol 4P/ Parati 4P DNT. / Saveiro Ger II / III / IV 98...2007
 C/ Motor - S/ Motor - Fixação Motor Mabuchi
 Nº Orig. 373.837.501-B (LE) / 373.837.502-B (LD)

KOMBI



R-4176 E/D
Máquina Reguladora
 Kombi Clipper Todas
 C/ Motor - S/ Motor - Fixação Motor Mabuchi
 Nº Orig. 211.837.501.1 (LE) / 211.837.502.1 (LD)

GOLF



R-4178 E/D
Reparo
 Golf 4P 2000... Polo 2002... DNT. / Amarok DNT. / TRS.
 C/ Motor - S/ Motor - Fixação Motor Mabuchi
 Nº Orig. IJ3.837.461-D (LE) / IJ3.837.462-D (LD)

FOX



R-4180 E/D
Máquina Reguladora
 Fox 2P 2003...
 C/ Motor - S/ Motor - Fixação Motor Mabuchi
 Nº Orig. 5Z3.837.501.A (LE) / 5Z3.837.502.A (LD)

FOX



R-4181 E/D
Máquina Reguladora
 Fox 4P DNT. 2003...
 C/ Motor - S/ Motor - Fixação Motor Mabuchi
 Nº Orig. 5Z4.837.401.A (LE) / 5Z4.837.402.A (LD)

FOX



R-4182 E/D
Máquina Reguladora
 Fox 4P TRS. 2003...
 C/ Motor - S/ Motor - Fixação Motor Mabuchi
 Nº Orig. 5Z4.839.401 (LE) / 5Z4.839.402 (LD)

FOX



R-4183 E/D
Máquina Reguladora
 Fox 4P TRS. 2003...
 Somente sem Motor - Fixação Motor Original
 Nº Orig. 5Z4.839.401 (LE) / 5Z4.839.402 (LD)

GOL MOTOR INVERTIDO

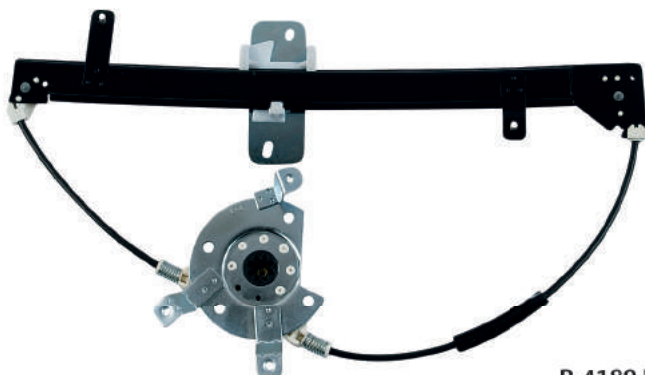

R-4189 E/D
Máquina Reguladora
 Gol / Parati GII/ GIII/ GIV 4P TRS. 98...2007
 C/ Motor - S/ Motor - Fixação Motor Mabuchi
 Nº Orig. 373.839.501.B.SM (LE) / 373.839.502.B.SM (LD)

SANTANA MOTOR INVERTIDO



R-4190 E/D
Máquina Reguladora
 Santana 2 / 4P DNT. 86...98
 C/ Motor - S/ Motor - Fixação Motor Mabuchi
 Nº Orig. ZBC.837.501.A (LE) / ZBC.837.502.A (LD)

SANTANA MOTOR INVERTIDO

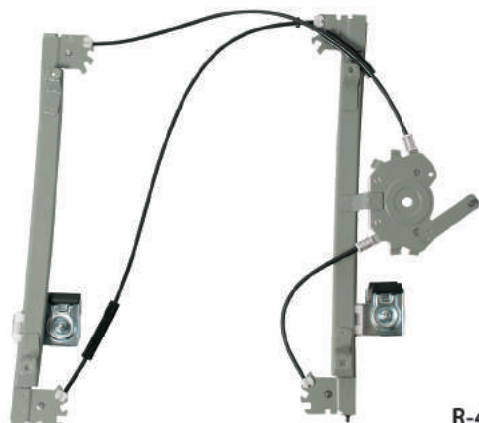

R-4191 E/D
Máquina Reguladora
 Santana 4P DNT. 98...
 C/ Motor - S/ Motor - Fixação Motor Mabuchi
 Nº Orig. 327.837.501-3 (LE) / 327.837.502-3 (LD)

SANTANA MOTOR INVERTIDO



R-4192 E/D
Máquina Reguladora
 Santana 4P TRS. 86...98
 C/ Motor - S/ Motor - Fixação Motor Mabuchi
 Nº Orig. ZBD.839.501.A (LE) / ZBD.839.502.A (LD)

SANTANA



R-4193 E/D
Máquina Reguladora
 Santana 2/4P DNT. 86...98 SM
 Somente sem Motor - Fixação Motor Carto
Nº Orig. 327.837.501-5 (LE) / 327.837.502-5 (LD)

SANTANA

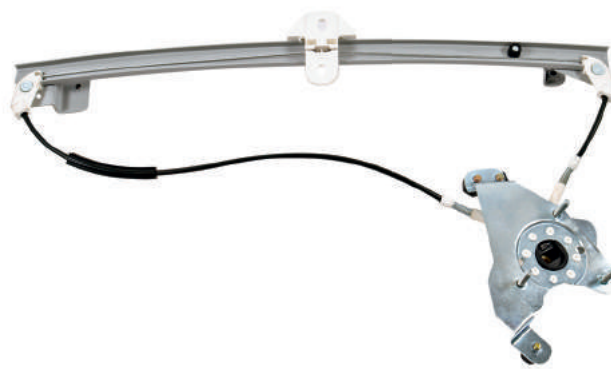

R-4194 E/D
Máquina Reguladora
 Santana 4P TRS. 86...98 SM
 Somente sem Motor - Fixação Motor Carto
Nº Orig. 327.839.501-5 (LE) / 327.839.502-5 (LD)

CAMINHÃO VW 80/...

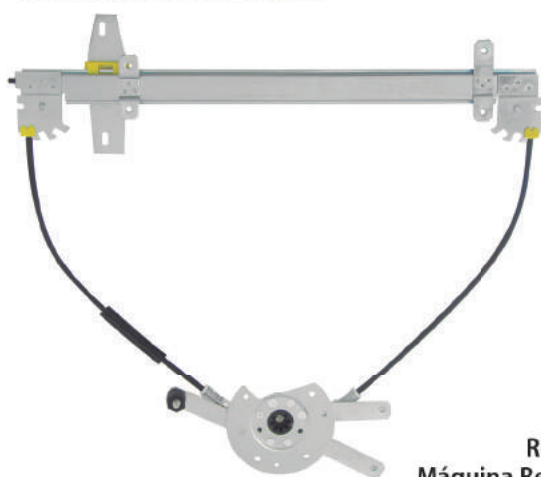

R-4195 E/D
Máquina Reguladora
 Caminhão Volkswagen 80... Todos - 12/24 Volts
 C/ Motor - S/ Motor - Fixação Motor Mabuchi
Nº Orig. TF3.837.501.EL (LE) / TF3.837.502.EL (LD)

TRACTOR CONSTELLATION

MOTOR INVERTIDO



R-4196 E/D
Máquina Reguladora
 Caminhão Volkswagen Tractor Constellation 2007...
 13180/15180/17250/19320/24250/26260 24V
 C/ Motor - S/ Motor - Fixação Motor Mabuchi
Nº Orig. 2R2.837.399 (LE) / 2R2.837.400 (LD)

FOX



R-4198 E/D
Máquina Reguladora
 Fox 2P 2003...
 Somente sem Motor - Fixação Motor Original
Nº Orig. 5Z3.837.501.A (LE) / 5Z3.837.502.A (LD)

FOX

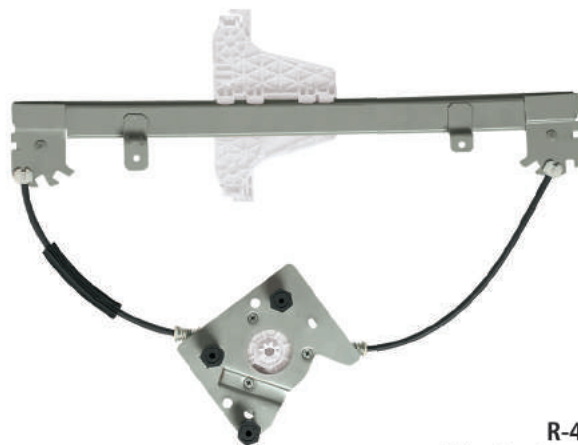

R-4199 E/D
Máquina Reguladora
 Fox 4P DNT. 2003...
 Somente sem Motor - Fixação Motor Original
Nº Orig. 5Z4.837.401.A (LE) / 5Z4.837.402.A (LD)

ESCORT



R-4173 E/D
Máquina Reguladora

Escort 2P 93...96
C/ Motor - S/ Motor - Fixação Motor Mabuchi
Nº Orig. 547.837.501.D (LE) / 547.837.502. D (LD)

KA MOTOR INVERTIDO



R-5145 E/D
Máquina Reguladora

Ford Ka 97...2007
C/ Motor - S/ Motor - Fixação Motor Mabuchi
Nº Orig. 97KG.B23201.BE (LE) / 97KG.B23200.BE (LD)

RANGER MOTOR INVERTIDO



R-5147 E/D
Máquina Reguladora

Ranger DNT...2011
C/ Motor - S/ Motor - Fixação Motor Mabuchi
Nº Orig. F57Z.102.3209.AA (LE) / F57Z.102.3208.AA (LD)

KA



R-5151 E/D
Máquina Reguladora

Ford Ka 2008...
C/ Motor - S/ Motor - Fixação Motor Mabuchi
Nº Orig. 96KG.B23201.BE.SM (LE) / 96KG.B23200.BE.SM (LD)

RANGER

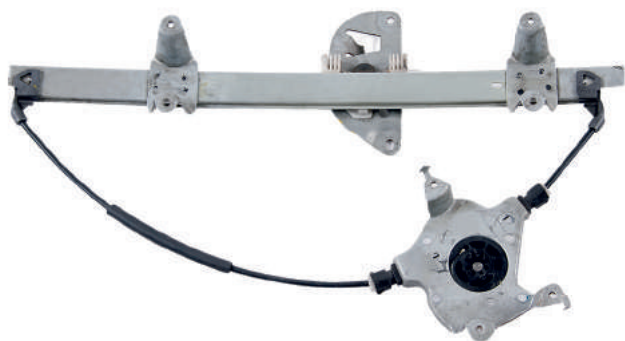

R-5153 E/D
Máquina Reguladora

Ranger TRS ...2011
C/ Motor - S/ Motor - Fixação Motor Mabuchi
Nº Orig. 7L55.352.7001 AA (LE) / 7L55.352.7000 AA (LD)

FIESTA STREET

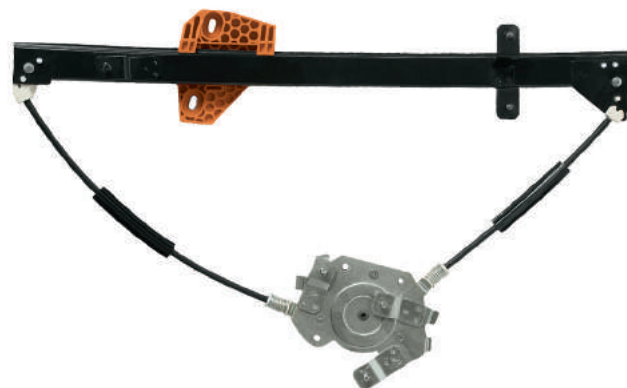

R-5218 E/D
Máquina Reguladora

Fiesta Street 4P DNT. 96...2003
C/ Motor - S/ Motor - Fixação Motor Mabuchi
Nº Orig. 96/FGA23201.BB (LE) / 96/FGA23200.BB (LD)

FIESTA STREET



R-5219 E/D
Máquina Reguladora
 Fiesta Street 2P 96...2003) Courier 96...
 C/ Motor - S/ Motor - Fixação Motor Mabuchi
Nº Orig. 98FG/B23201/BA (LE) / 96FG/B23200/BA (LD)

F1000 ANTIGA MOTOR INVERTIDO

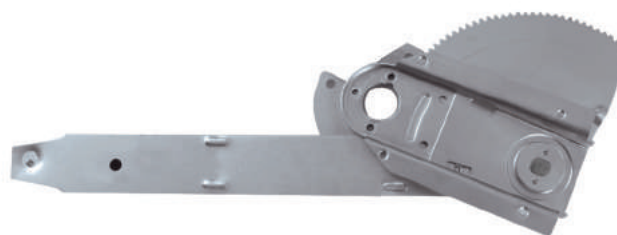

R-5222 E/D
Máquina Reguladora
 F600 / F1000 / F4000 Caminhão 72...91
 C/ Motor - S/ Motor - Fixação Motor Mabuchi
Nº Orig. 89TU.81234W01B (LE) / 89TU.81234W00B (LD)

ECOSPORT



R-5224 E/D
Máquina Reguladora
 Ecosport 4P DNT. 2002...2012
 C/ Motor - S/ Motor - Fixação Motor Mabuchi
Nº Orig. 2N15M23201 BE (LE) / 2N15M23200 BE (LD)

ECOSPORT



R-5225 E/D
Máquina Reguladora
 Ecosport 4P TRS. 2002...2012
 C/ Motor - S/ Motor - Fixação Motor Mabuchi
Nº Orig. 2N15N27001 BD (LE) / 2N15N27000 BD (LD)

RANGER



R-5227 E/D
Máquina Reguladora
 Ranger DNT. 2012...
 C/ Motor - S/ Motor - Fixação Motor Mabuchi
Nº Orig. AB.392.123.201BC (LE) / AB.392.123.200BC (LD)

RANGER



R-5228 E/D
Máquina Reguladora
 Ranger TRS. 2012...
 C/ Motor - S/ Motor - Fixação Motor Mabuchi
Nº Orig. AB.392.627.001BC (LE) / AB.392.627.000BC (LD)

F1000 MODERNA MOTOR INVERTIDO



R-5229 E/D
Máquina Reguladora
 F 1000 / F 4000 92...99 (Sapão)
 C/ Motor - S/ Motor - Fixação Motor Mabuchi
Nº Orig. 2SA.837.501A (LE) / 2SA.837.502A (LD)

ESCORT

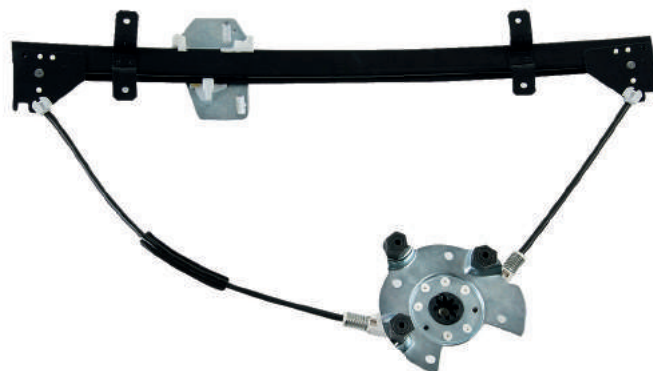

R-5230 E/D
Máquina Reguladora
 Escort SW Zetec 4P 97... Pointer / Verona 93...96 DNT
 C/ Motor - S/ Motor - Fixação Motor Mabuchi
Nº Orig. 97.AGA.23201AA (LE) / 97.AGA.23200AA (LD)

FIESTA AMAZON



R-5231 E/D
Máquina Reguladora
 Fiesta Amazon 4P DNT. 2002...
 C/ Motor - S/ Motor - Fixação Motor Mabuchi
Nº Orig. 2S65A.23201BF (LE) / 2S65A.23200BF (LD)

ESCORT

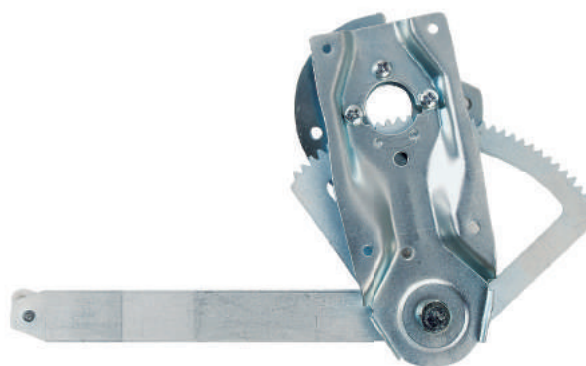

R-5232 E/D
Máquina Reguladora
 Escort SW - Zetec 4P 97... Pointer / Verona 93...96 TRS.
 C/ Motor - S/ Motor - Fixação Motor Mabuchi
Nº Orig. 97.AGA.27001BA (LE) / 97.AGA.27000BA (LD)

CARGO

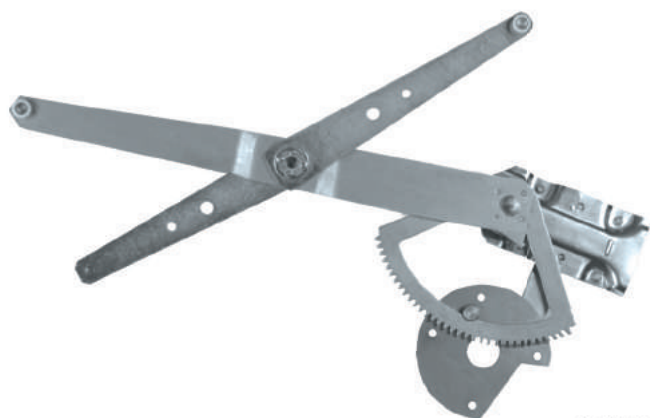

R-5233 E/D
Máquina Reguladora
 Caminhão Cargo 81... 12V / 24 V /
 C/ Motor - S/ Motor - Fixação Motor Mabuchi
Nº Orig. 81DBE23201AJ (LE) / 81DBE23200AJ (LD)

FIESTA AMAZON



R-5234 E/D
Máquina Reguladora
 Fiesta Amazon 4P TRS. 2002...
 C/ Motor - S/ Motor - Fixação Motor Mabuchi
Nº Orig. 2S65A27001BF (LE) / 2S65A27000BF (LD)

LINHA FORD



F-250



R-5235 E/D
Máquina Reguladora
F-250/ F-350/ F-4000 2000... 12/24V/
C/ Motor - S/ Motor - Fixação Motor Mabuchi
Nº Orig. XC3Z.2523.201.BA (LE) / XC3Z.2523.200.BA (LD)

CARGO

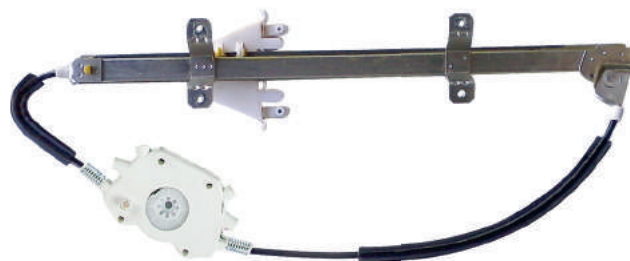

R-5236 E/D
Máquina Reguladora
Ford Cargo 2011... 12/24 V/
C/ Motor - S/ Motor - Fixação Motor Mabuchi
Nº Orig. 3C46.E23201.BE (LE) / 3C46.E23200.BE (LD)

CARGO

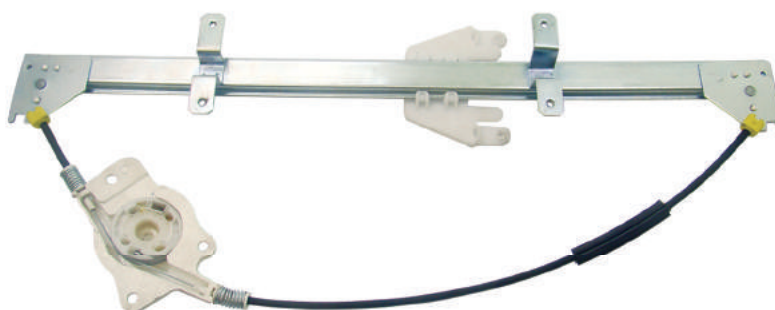

R-5237 E/D
Máquina Reguladora
Ford Cargo 2011...
Somente sem Motor – Fixação Motor Original
Nº Orig. 3C4.6E2.320.1BE (LE) / 3C4.6E2.320.0BE (LD)

LINHA MITSUBISHI



L200



R-7490 E/D
Máquina Reguladora
L200 Triton 4P DNT. 2008...
C/ Motor – S/ Motor – Fixação Motor Mabuchi
Nº Orig. 18.23.65 (LE) / 18.23.66 (LD)

L200

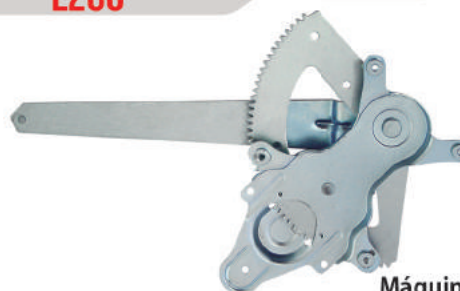

R-7491 E/D
Máquina Reguladora
L200 Triton 4P TRS. 2008...
C/ Motor – S/ Motor – Fixação Motor Mabuchi
Nº Orig. 18.24.03 (LE) / 18.24.04 (LD)

CLIO

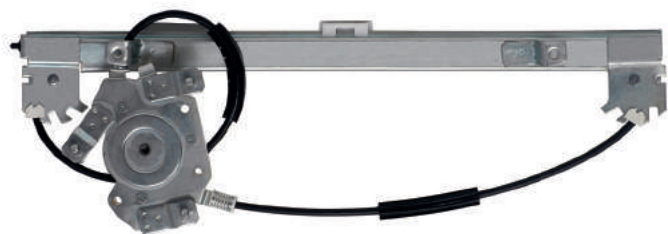

R-7500 E/D
Máquina Reguladora
Clio 2P 99...

C/ Motor - S/ Motor - Fixação Motor Mabuchi
Nº Orig. 77.008.422.47 (LE) / 77.008.422.46 (LD)

CLIO



R-7501 E/D
Máquina Reguladora
Clio 4P DNT. 99...

C/ Motor - S/ Motor - Fixação Motor Mabuchi
Nº Orig. 77.00.84.22.41 (LE) / 77.00.84.22.40 (LD)

LOGAN



R-7502 E/D
Máquina Reguladora
Logan 4P DNT. 2007...

C/ Motor - S/ Motor - Fixação Motor Mabuchi
Nº Orig. 82.006.195.99 (LE) / 82.006.195.97 (LD)

SANDERO

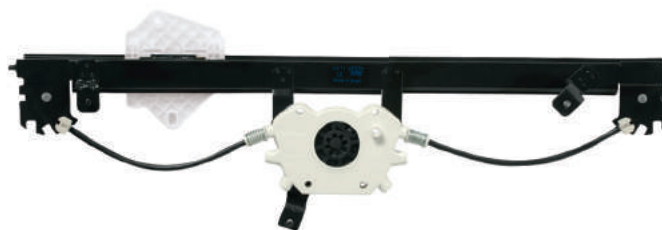

R-7503 E/D
Máquina Reguladora
Sandero 4P DNT. 2008...

C/ Motor - S/ Motor - Fixação Motor Mabuchi
Nº Orig. 82.006.038.58 (LE) / 82.006.038.62 (LD)

LOGAN

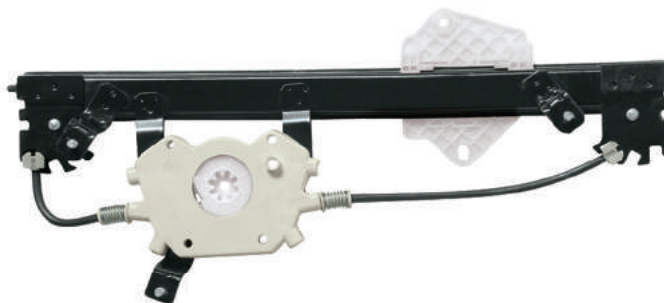

R-7504 E/D
Máquina Reguladora
Logan 4P TRS. 2007...

C/ Motor - S/ Motor - Fixação Motor Mabuchi
Nº Orig. 82.006.195.89 (LE) / 82.006.195.88 (LD)

SANDERO

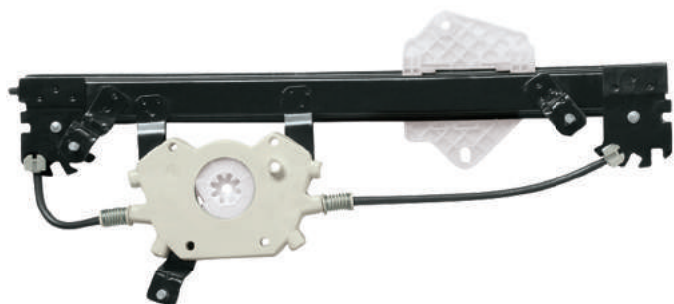

R-7505 E/D
Máquina Reguladora
 Sandero 4P TRS. 2008...
 C/ Motor - S/ Motor - Fixação Motor Mabuchi
Nº Orig. 82.006.037.95 (LE) / 82.006.038.10 (LD)

MASTER



R-7506 E/D
Máquina Reguladora
 Master 2013...
 C/ Motor - S/ Motor - Fixação Motor Mabuchi
Nº Orig. 820.046.797.1 (LE) / 820.046.796.7 (LD)

KANGOO



R-7507 E/D
Máquina Reguladora
 Kangoo
 C/ Motor - S/ Motor - Fixação Motor Original
Nº Orig. 00.00.00. (LE) / 00.00.00. (LD)

LOGAN/SANDERO MOTOR INVERTIDO



R-7508 E/D
Máquina Reguladora
 Logan / Sandero 4P DNT Nov-2013...
 C/ Motor - S/ Motor - Fixação Motor Mabuchi
Nº Orig. 80.720.9299R (LE) / 80.721.1440R (LD)

LOGAN/SANDERO MOTOR INVERTIDO



R-7509 E/D
Máquina Reguladora
 Logan / Sandero 4P TRS Nov-2013...
 C/ Motor - S/ Motor - Fixação Motor Mabuchi
Nº Orig. 82.721.1331R (LE) / 82.720.6057R (LD)

LINHA PEUGEOT



PEUGEOT 206



R-7510 E/D Reparo

Reparo P/ Máquina Reg. Peugeot 206 2/4P DNT. /
C/ Motor - S/ Motor - Fixação Motor Mabuchi
Nº Orig. E-0.000.000/D-0.000.000

PEUGEOT 207



R-7511 E/D Máquina Reguladora

Peugeot 207 4P DNT. / Hoggar 2009...
C/ Motor - S/ Motor - Fixação Motor Mabuchi
Nº Orig. 160.784.81.80 (LE) / 160.784.80.80 (LD)

PEUGEOT 207



R-7512 E/D Máquina Reguladora

Peugeot 207 4P TRS. 2009...
C/ Motor - S/ Motor - Fixação Motor Mabuchi
Nº Orig. 160.784.83.80 (LE) / 160.784.82.80 (LD)

LINHA NISSAN



MARCH



R-7515 E/D Máquina Reguladora

March/ Versa 4P DNT. 2011...
C/ Motor - S/ Motor - Fixação Motor Mabuchi
Nº Orig. 807.211.HL0A (LE) / 807.201.HL0A (LD)

MARCH MOTOR INVERTIDO



R-7516 E/D Máquina Reguladora

March/ Versa 4P TRS. 2011...
C/ Motor - S/ Motor - Fixação Motor Mabuchi
Nº Orig. 827.211.HL0A (LE) / 827.201.HL0A (LD)

ETIOS

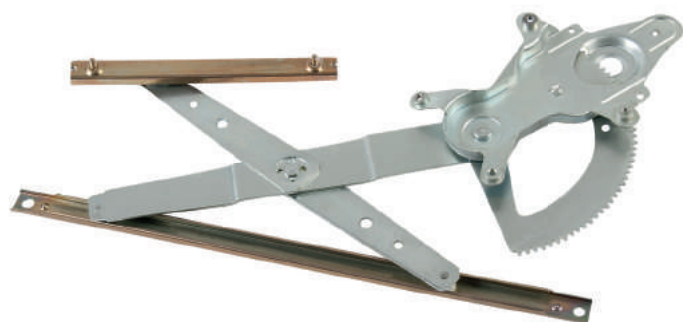

R-7517 E/D
Máquina Reguladora
Etios 4P DNT. 2012...

C/ Motor - S/ Motor - Fixação Motor Mabuchi
Nº Orig. 69.802.0D.160 (LE) / 69.801.0D.150 (LD)

ETIOS

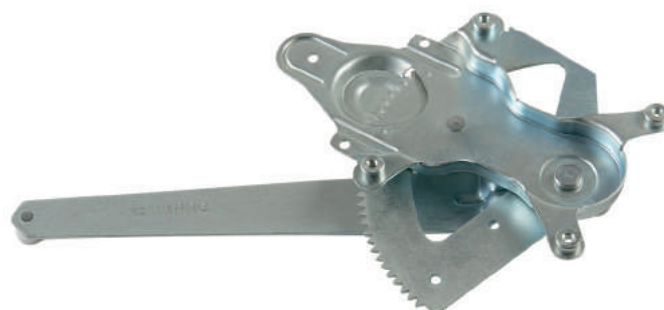

R-7518 E/D
Máquina Reguladora
Etios 4P TRS. 2012...

C/ Motor - S/ Motor - Fixação Motor Mabuchi
Nº Orig. 69.804.0D. 130 (LE) / 69.803.0D.130 (LD)

HILUX



R-7519E/D
Máquina Reguladora
Hilux DNT. /

C/ Motor - S/ Motor - Fixação Motor Mabuchi
Nº Orig. 69802.0K051 (LE) / 69801.0K051 (LD)

HILUX



R-7520E/D
Máquina Reguladora
Hilux TRS. /

C/ Motor - S/ Motor - Fixação Motor Mabuchi
Nº Orig. 69804.0K051 (LE) / 69803.0K051 (LD)

CAMINHÃO HR



R-7521 E/D
Máquina Reguladora
Caminhão HR Todos
C/ Motor - S/ Motor - Fixação Motor Mabuchi
Nº Orig. 82.401.4F.000 (LE) / 82.402.4F.000 (LD)

HB20



R-7522 E/D
Máquina Reguladora
HB20 / HB20S 4P DNT. 2012...
C/ Motor - S/ Motor - Fixação Motor Mabuchi
Nº Orig. 82.403.1S.010 (LE) / 82.404.1S.010 (LD)

HB20

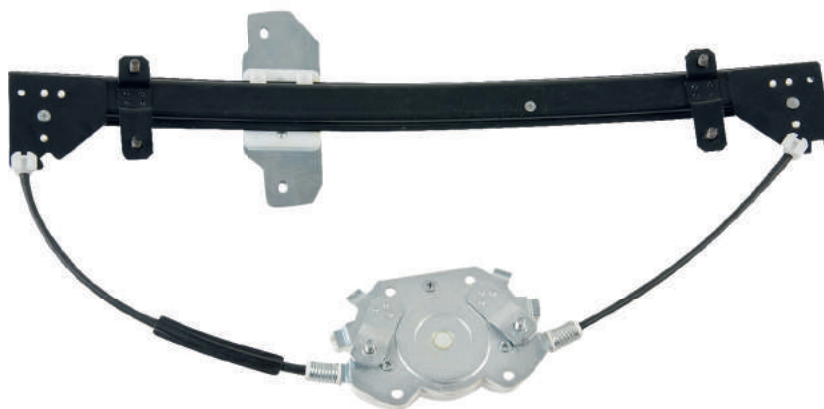

R-7523 E/D
Máquina Reguladora
HB20 / HB20S 4P TRS. 2012...
C/ Motor - S/ Motor - Fixação Motor Mabuchi
Nº Orig. 83.403.1S.010 (LE) / 83.404.1S.010 (LD)

MODELO MABUCHI 12V

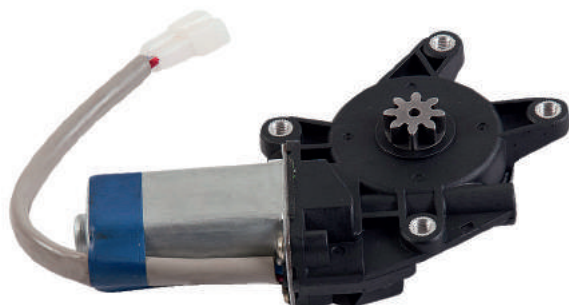

Motor lado esquerdo



Motor lado direito

M-6700 E/D
Motor Modelo Mabuchi 12 Volts

MODELO MABUCHI 24V

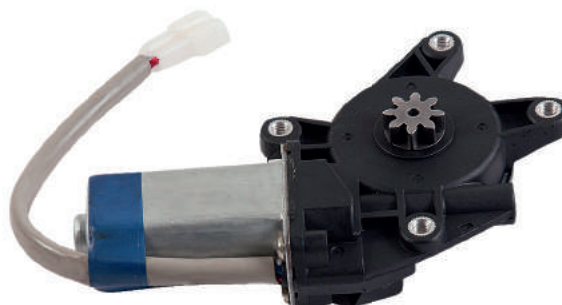

Motor lado esquerdo



Motor lado direito

M-6701 E/D
Motor Modelo Mabuchi 24 Volts

SCANIA SÉRIE 4 /VOLVO FH

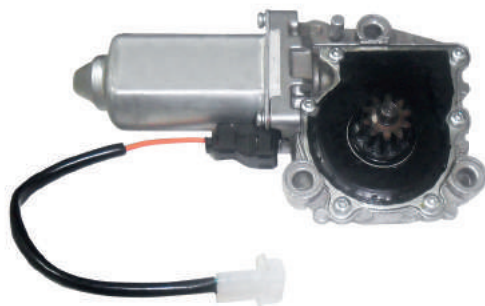

Motor lado esquerdo

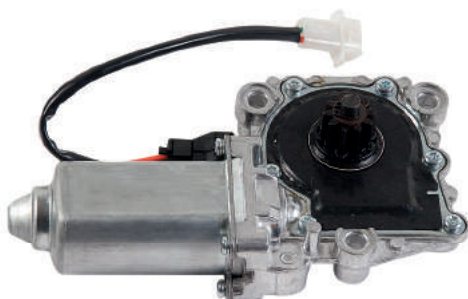

Motor lado direito

M-6702 E/D
Motor Modelo Original 24 Volts para o Scania Série 4 e Volvo FH

SCANIA SÉRIE 3

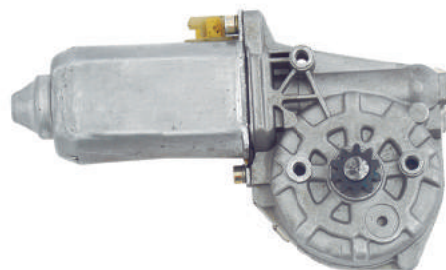

Motor lado esquerdo

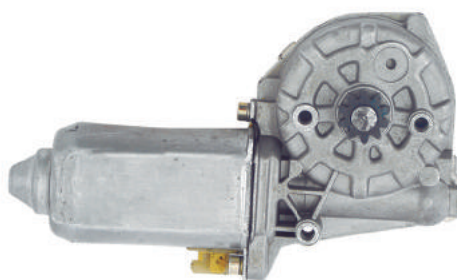

Motor lado direito

M-6703 E/D
Motor Modelo Original 24 Volts para o Scania Série 3



Zinni & Güell Ltda

📍 Estrada da Água Chata, 1233

📍 CEP: 07251-000 • Bonsucesso • Guarulhos • SP • Brasil

📞 TEL.: (55 11) 2480-4448 • Fax: (55 11) 2480-2680

⚙️ Assistência Técnica: 0800 7701425

🌐 www.zinnieguell.com.br • vendas@zinnieguell.com.br